

**Preliminary Economic Assessment for the
El Cajon Borate Deposit
Magdalena Basin Project, Sonora, Mexico
(Pursuant to National Instrument 43-101 of
the Canadian Securities Administrators)**

**Magdalena de Kino Area
(Map Sheet H1205)
Sonora, Mexico
centered at: 30°30'N, 110°50'W**

For



330 – 808 – 4th Avenue S. W.
Calgary, Alberta
Canada T2P 3E8
Tel. +1-403-237-6122

By

Geoff Allard, P.E.
Allard Engineering Services, LLC
4526 N. Camino De La Codorniz
Tucson, Arizona
U.S.A. 85745
Tel. +1-520-743-5185

Carl G. Verley, P.Geo.
Geological Consultant
Amerlin Exploration Services Ltd.
2150 – 1851 Savage Road
Richmond, B.C. Canada V6V 1R1
Tel. +1-604-821-1088

Ramon Salazar Velazquez, Lic. Eng.
Geological Consultant
Calle de la Cantera # 6
Hermosillo,
Mexico
Tel. +52-662-220-3396

Martin F. Vidal, Lic. Geo.
Vice-President, Exploration
Bacanora Minerals Ltd.
Calle Uno # 312
Hermosillo, Mexico
Tel. +52-662-210-0767

Dated: January 4, 2013.

Date and Signature Page

Date

Dated Effective: January 4, 2013.

Signatures

signed "*Geoff Allard*"
Geoff Allard, P.E.

signed "*Ramon Salazar Velazquez*"
Ramon Salazar Velazquez

signed "*Carl G. Verley*"
Carl G. Verley, P.Geol.

signed "*Martin F. Vidal*"
Martin F. Vidal, Lic. Geo.

Table of Contents

Date and Signature Page	ii
1.0 Summary	1
2.0 Introduction.....	4
3.0 Reliance on Other Experts	4
4.0 Property Description and Location	5
5.0 Accessibility, Climate, Local Resources, Infrastructure and Physiography	7
5.1 Accessibility	7
5.2 Climate and Physiography	7
5.3 Local Resources and Infrastructure.....	7
6.0 History.....	8
7.0 Geological Setting and Mineralization	10
7.1 Regional Geology.....	10
7.2 Property Geology	12
7.3 Mineralization	13
8.0 Deposit Types	17
8.1 Borate Deposits	17
9.0 Exploration.....	18
10.0 Drilling.....	18
10.1 Drilling in 2010:.....	18
10.2 Drilling in 2011	21
10.3 Drilling in 2012	26
11.0 Sample Preparation, Analyses and Security	29
12.0 Data Verification.....	31
13.0 Mineral Processing and Metallurgical Testing	32
13.1 Test Composites:.....	32
13.2 Scrubbing/De-sliming:	34
13.3 Flotation:	35
13.4 Analytical:	36
13.5 Arsenic:	37
13.6 Thermal Processing - Calcining:.....	37
13.7 Other Considerations:.....	39
14.0 Mineral Resource Estimates	40
14.1 Methodology	41
15.0 Mineral Reserve Estimates	43
16.0 Mining Methods.....	43
17.0 Recovery Methods	46
17.1 Colemanite	46

17.2 Boric acid	47
18.0 Project Infrastructure	48
19.0 Market Studies and Contract.....	49
20.0 Environmental Studies, Permitting and Social or Community Impact.....	49
21.0 Capital and Operating Costs	50
22.0 Economic Analysis	52
23.0 Adjacent Properties.....	53
23.1 Unimin Borate Deposit:	53
23.2 Yeso Mine:	53
24.0 Other Relevant Data and Information.....	54
25.0 Interpretations and Conclusions.....	55
26.0 Recommendations.....	56
27.0 References.....	57

List of Figures

Figure 1. Cajon Borate Deposit Location Map.....	3
Figure 2. Location of the Magdalena Basin Project	5
Figure 3. Locations of US Borax drill holes on the El Cajon deposit	9
Figure 4. Geology of the Magdalena Basin and Project area	11
Figure 5. Stratigraphy of the Magdalena Basin	11
Figure 6. Surface geology of Cajon Deposit.....	13
Figure 7. Drill hole location plan, 2010 and earlier holes, El Cajon Deposit.....	19
Figure 8. Geological Cross Section through the El Cajon Borate Deposit.....	20
Figure 9. Drill hole location plan, 2011 and earlier holes, El Cajon Deposit.....	21
Figure 10. Drill hole location plan, 2012 and earlier holes, El Cajon Deposit.....	26
Figure 11. Flow chart of core sample handling	30
Figure 12. Location Map of Drill Holes Comprising Composites A2 and A3.....	33
Figure 13. Typical Grade/Recovery Curves for Composites A2 and A3.....	36
Figure 14. Effect of Calcining on Composite A3.....	38
Figure 15. EL Cajon deposit Isometric Model.....	41
Figure 16. Plan of Proposed Mine Pit, Plant, Dumps and Tailings.....	44
Figure 17. View of Planned Pit relative to Colemanite-bearing Unit A.....	45
Figure 18. Conceptual Colemanite Process Flow Diagram.....	47
Figure 19. Conceptual Boric Acid Process Flow Diagram.....	48
Figure 20. Map of Adjacent properties	54

List of Tables

Table 1: Abbreviations used in this report.....	vi
Table 2. Preliminary Financial Highlights ¹	2
Table 3. Concession status, Magdalena Basin Project.....	5
Table 4. Chronology of exploration in the Magdalena Project area	8
Table 5. Fluvial-Lacustrine member of the Cajon-Pozo Nuevo sequence	15
Table 6. Thickness and grade characteristics of the El Cajon Borate Deposit	16
Table 7. Significant Borate Drill Intercepts 2010 & MSM Programs, El Cajon Deposit.....	20
Table 8. Significant Borate Drill Intercepts 2011 program, El Cajon Deposit.....	21
Table 9. Significant Borate Drill Intercepts 2012 program, El Cajon Deposit.....	26
Table 10. Analyses of Bacanora Boron standards	31
Table 11. Drill Core Selection for Composite 2A.	32
Table 12. Drill Core Selection for Composite 3A.	33
Table 13. Mass and B ₂ O ₃ from Feed Reporting to Slimes.	34
Table 14. Typical Feed to Rougher Flotation.	34
Table 15. Typical Batch Flotation Response for Composite 2A (rejects).	35
Table 16. Typical Batch Flotation Response for Composite 3A.	35
Table 17. Analyses of Boric Acid and Concentrate Using MSB Procedure.	37
Table 18. Arsenic Assays in ppm of Composite 2A Tails and Concentrates.	37
Table 19. Resource Estimate Summary	40
Table 20. Potential Ore-Waste ratio and ore grade (B ₂ O ₃).....	44
Table 21. Anticipated Mining Equipment	45
Table 22. Key Operating Cost Assumptions.....	50
Table 23. Estimated Annual Mining and Processing Costs.....	51
Table 24. Development Capital Requirements	51
Table 25. Cash Flow and Net Present Value Analysis Projected Over Life of Mine.....	52
Table 26. Estimated Cost of Recommended Program	56

Table 1: Abbreviations used in this report

ASL	Above Sea Level
B₂O₃	Chemical symbol for borate, a boron compound
°C	Degrees Celsius
Col	Colemanite
CIM	Canadian Institute of Mining & Metallurgy
CRZ	Carbonate replacement of colemanite zones
Cum.	Cumulative
Fm	Geological formation
gm	gram
ha	Hectares
ICP-OES	Inductively coupled plasma – optical emission spectrometry – an analytical technique
ISO	International Standards Organization
km	Kilometre/kilometres
Ma	Millions of years before present
m	Metre/Metres
mm	Millimetre/millimetres
M	Mega or million
NAD	North American map Datum
NQ	A size of drill core 47.6 mm in diameter
OB	Overburden
ppm	Parts per million
QP	Qualified Person as defined by NI 43-101
S.A. de C.V.	Mexican legal term: Sociedad Anónima de Capital Variable or variable capital corporation, the common form for a corporate entity in Mexico

1.0 Summary

The Cajon Borate Deposit (“Cajon”, “El Cajon”, or “the Property”) lies within Bacanora Minerals Ltd.’s Magdalena Basin Project area in the state of Sonora, Northern Mexico. The Magdalena Basin Project consists of 2 concession blocks covering a total of 15,508 hectares. El Cajon covers approximately 500 ha on the southern part of one of the concession blocks. The concessions are 100% owned by Bacanora’s Mexican subsidiary: Minera Sonora Borax S.A. de C.V., subject to a 3% royalty to a Rio Tinto subsidiary and a 3% gross over-riding royalty to Colin Orr-Ewing.

El Cajon is road accessible and located 17 kilometres east of the town of Magdalena de Kino and has excellent access from that center, either by rail or truck, to local markets for borate or to overseas markets from the port at Guaymas.

Colemanite ($\text{Ca}_2\text{B}_6\text{O}_{11}\cdot 5\text{H}_2\text{O}$), which contains up to 50.8% borate (B_2O_3), is the primary mineral of interest. Colemanite is hosted in a Miocene age sediment-volcaniclastic succession that in-fills extensional sub-basins formed over metamorphic core complexes that underlie much of the Great Basin - a basin and range physiographic province extending from northern Nevada down into Sonora.

Three main borate zones have been located on the Magdalena project area: Cajon; Bellota and Pozo Nuevo. Other targets include the recently discovered Represo colemanite prospect and the Escuadra occurrence. All of these zones were discovered by previous operators who conducted drilling programs at these sites in the 1970's and 1980's. US Borax was the main sponsor of the work. However, none of the discoveries was put into production in part because of the take-over of US Borax by Rio Tinto Zinc. The Represo prospect is a new colemanite discovery that was recently made by Bacanora during a drilling campaign.

Of the main borate zones El Cajon is the most advanced. This report provides an update of resources at El Cajon and provides a preliminary economic assessment of the deposit. Drilling by Bacanora (48 holes) and a US Borax subsidiary (11 holes) has identified 3 separate colemanite horizons (units: A, B and C) within the gently south-dipping sediments that underlie the area of El Cajon. The drilling has allowed an indicated borate resource of 11 million tonnes averaging 10.6% B_2O_3 to be estimated for El Cajon under CIM resource-reserve criteria. The estimate includes indicated resources for unit A of 7.5 million tonnes averaging 10.8% B_2O_3 , 0.8 million tonnes averaging 9.0% B_2O_3 for unit B and 2.7 million tonnes averaging 10.5% B_2O_3 for unit C using a cut off of 8% B_2O_3 . The average thickness for each bed making up the 3 units ranges from 4.2 to 9.8 metres. Readers are cautioned that mineral resources used in this preliminary economic assessment are not mineral reserves as they do not have demonstrated economic viability.

Initial metallurgical test work has indicated that a colemanite concentrate grading 38% - 42% B_2O_3 can be produced from an average feed of 10.5% B_2O_3 from El Cajon using a combination of scrubbing, de-sliming and flotation. Construction of a pilot plant in order to conduct detailed metallurgy and improve the borate content of the colemanite concentrate, as well as finalize a full scale production flow sheet and produce colemanite concentrates for test marketing is 80% complete. In addition, it is recommended that a boric acid circuit be included in the pilot plant.

Potential buyers of colemanite concentrates have expressed a strong interest purchasing colemanite from Bacanora should it be able to produce concentrates that meet these consumers' specifications.

Highlights of a preliminary economic analysis of a potential colemanite mine and production facility with a mining rate of 231,100 tonnes averaging 10.5% B₂O₃ per annum to yield 50,000 tonnes of 40-42% colemanite concentrate per year over a 25 year mine life suggest annual revenue of \$US25 million for an IRR of 24.8% with a 4 year pay back. Capital costs are estimated at \$US7.25 million and average operating costs at \$US170/tonne. Net present value (NPV) of the project, discounted at 8%, is \$US113 million, assuming an average colemanite concentrate price of \$US500/tonne. The preliminary economic assessment includes forward looking information including, but not limited to assumptions concerning colemanite prices, cash flow forecasts, project capital and operating costs, commodity recoveries, mine life and production rates. Readers are cautioned that actual results may vary from those presented. Further testing will need to be undertaken to confirm economic feasibility of the El Cajon deposit.

Table 2. Preliminary Financial Highlights

Open Pit Mine Production per annum	231,100	tonnes @ 10.5% B ₂ O ₃
Colemanite concentrate production per annum	50,000	tonnes @ 42% B ₂ O ₃
Revenue (\$US500/tonne of colemanite concentrate) per annum	\$25	million
Cumulative NPV (8% Discount)	\$US113	million
Internal rate of return (IRR)	24.8%	
Average Operating costs	\$US170	per tonne
Total Initial Capital Costs	\$US7.25	million
Expected Mine Life	25	years
Pay Back of Capital Costs	4	year

Results of the exploration and preliminary metallurgical test work on the Cajon borate deposit are sufficiently encouraging to warrant further advanced exploration and development work on deposit.

A program of further exploration and development work is recommended to include:

1. Bulk sampling of borate mineralization from Cajon deposit,
2. Pilot plant construction and processing of colemanite mineralization in order to:
 - i) Produce colemanite concentrate and boric acid samples for potential buyers,
 - ii) Finalize colemanite and boric acid production flow-sheets.
3. Final mine planning, optimization of mining methods and possible in-fill diamond drilling of Unit A.

The estimated cost of the recommended program is \$US1.25 million of which expenditures for plant and equipment totaling \$US700,000 have been completed.

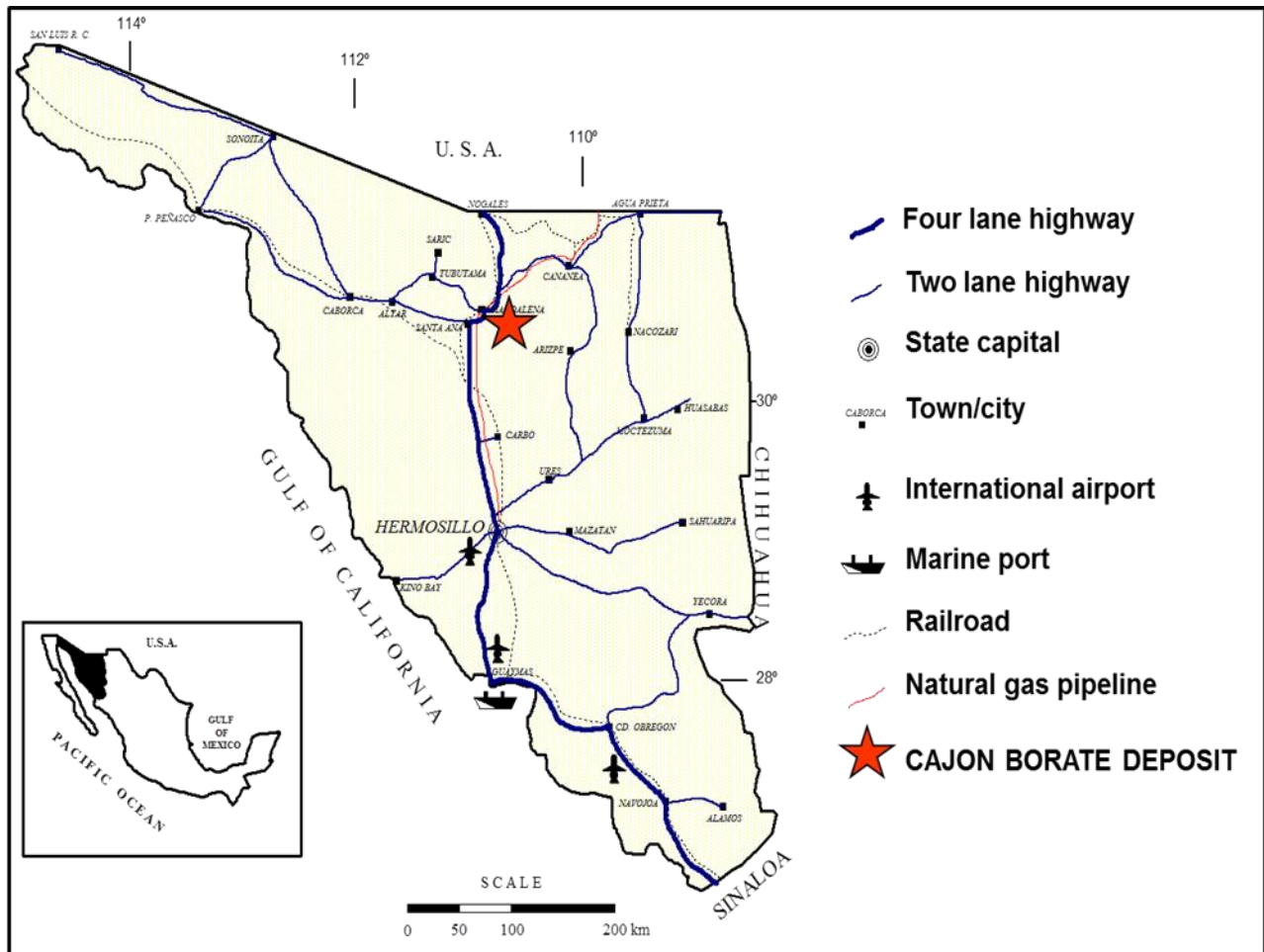

Figure 1. Cajon Borate Deposit Location Map

2.0 Introduction

This report was prepared at the request of Mr. Paul T. Conroy, President of Bacanora Minerals Ltd. (“Bacanora”).

The purpose of the report is to provide a preliminary economic assessment of the potential of the Cajon borate deposit based on NI 43-101 compliant indicated borate resources disclosed in this report.

Information contained in this report was sourced from Bacanora Minerals Ltd. survey data, drill logs, assay and analytical reports, Government of Mexico mineral titles data base and topographic maps. General information concerning regional geology and deposits types was sourced from references cited herein and listed at the end of this report.

The lead author and QP with overall responsibility for this report, Carl G. Verley, P.Geo., inspected the Cajon deposit during the period December 5 to 9, 2010, on June 8, 2012 and again from November 28 to December 6, 2012. During this time he examined and verified the location of some of the diamond drill holes on the Cajon deposit, examined the geology of the Cajon deposit in the field, examined the diamond drill core from Bacanora’s drilling of the Cajon deposit as well as reviewed all analytical data generated from exploration on the project including quality control and quality assurance protocols at the offices of Bacanora’s Mexican subsidiary, Minera Sonora Borax S.A. de C.V., in Hermosillo, Mexico.

Mr. Geoff Allard, P.E. has been supervising the metallurgical test work undertaken on colemanite-bearing drill core from the El Cajon project at the facilities of Laboratorio Técnico Metalurgico SA de CV in Hermosillo, Mexico since December, 2011. Mr. Allard has also been responsible for preparing the design specifications for the proposed pilot plant in order to test colemanite recoveries and provide samples of colemanite to consumers who may be interested in purchasing colemanite from Bacanora Minerals. Mr. Allard is responsible for Item 13 and 17.

Mr. Ramon Salazar Velazquez, Lic. Eng., prepared the revised mineral resource estimate for the Cajon borate deposit using inverse distance and kriging estimation methods based on information and data provided by Bacanora Minerals Ltd. Mr. Salazar is responsible for Item 14.0 of this report.

Mr. Martin F. Vidal, MSc, Lic. Geo., is responsible for managing the El Cajon exploration and development program. Many of the historical reports and some of the academic geological articles used in the preparation of this Technical Report were authored by Mr. Vidal, who is also Vice-President of Exploration for Bacanora Minerals Ltd. Mr. Vidal has worked consistently on the area now covered by the Magdalena concessions for various companies that have held licenses over the area during past 17 years. He is the principal author for most of the Minera Sonora Borax and Rio Tinto internal reports. Mr. Vidal is responsible for Items 6.0 to 8.0, 16.0 to 22.0 and 26 of this report.

3.0 Reliance on Other Experts

Reliance on other experts has not been used in the preparation of this report.

4.0 Property Description and Location

The Magdalena Property consists of 7 individual concessions in 2 separate parcels held by Bacanora's Mexican subsidiary: Minera Sonora Borax S.A. de C.V. (MSB). The property totals 16,503 hectares in area. The concessions are located approximately 180 km north of the city of Hermosillo, in Sonora State, Mexico, and are about 80 km south of the border with Arizona, USA. The Cajon deposit is located inside the San Francisco 2 and San Francisco Fraction 2 concessions with a possible extension to the south into the San Francisco 1 concession and a concession that belongs to Unimin in the northern edge. Table 3 lists the individual concessions.

Table 3. Concession status, Magdalena Basin Project

ConcessionName	Title #	Record Date	Expiry Date	Area Ha
San Francisco No. 1	217,709	10/13/2002	10/12/2052	2,303
San Francisco No. 2	217,948	09/18/2002	09/17/2052	583
San Francisco No. 3	217,949	09/18/2002	09/17/2052	351
San Francisco No. 5	220,721	09/30/2003	09/29/2053	1,500
San Francisco Fraction 1	226,247	12/02/2005	12/02/2055	2,344
San Francisco Fraction 2	226,247	12/02/2005	12/02/2055	4,980
El Represo	229,263	04/11/2007	04/10/2057	4,442

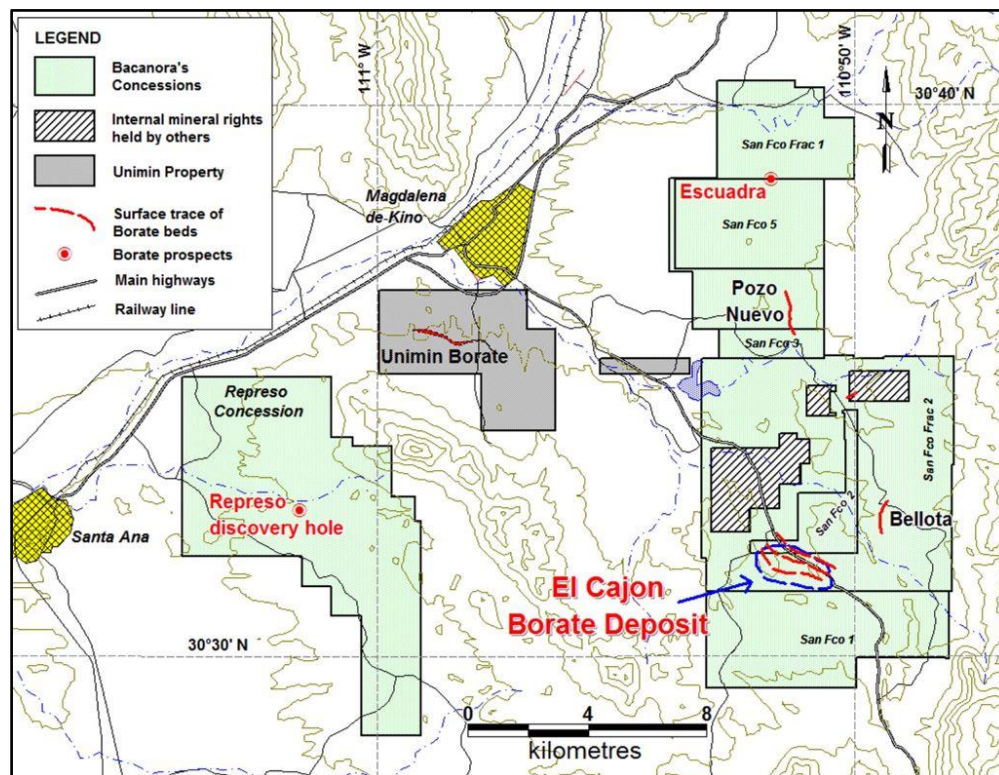

Figure 2. Location of the Magdalena Basin Project

Surface rights to the area underlain by the El Cajon Deposit are held by 1 cattle rancher. Access and land use agreements have been negotiated with the rancher giving Bacanora rights of access to the El Cajon deposit and rights to land use for the purpose of mining El Cajon. Bacanora cannot guarantee to have continuous and unencumbered right of access to the Property.

In order to retain the mineral rights to the Property Bacanora must comply with Mexican government regulations concerning semi-annual payment of property taxes which are based on the number of hectares held and the age of the concessions. In addition, on an annual basis, Bacanora must make prescribed minimum investments in exploration and development expenditures on the Property. The amounts required for minimum investments are provided in annual fee schedules released by the Mines Office. Title to mineral properties has inherent risks sometimes due to the difficulties of determining the validity of a title and at other times due to potential problems stemming from ambiguous conveyance history of some mineral properties. Bacanora has investigated title to all of its mineral properties and maintains them in compliance with Mexican Mining Law.

The Property is 100% owned by Bacanora subject to a 3% royalty to a Rio Tinto subsidiary and a 3% gross overriding royalty (“GOR”) to Colin Orr-Ewing.

The Property is not subject to any environmental liabilities, as far as the QPs’ have been able to ascertain.

In order to conduct exploration and mine development activities on the Property Bacanora must file and Environmental Impact report with the Mexican authorities. In addition, Bacanora must apply for Land Use permits with the Mexican authorities and the local land owners. To date Bacanora has all for the permits on hand that it requires to conduct the proposed work program on the Property.

There are no other significant factors or risks that the QPs’ have been able to determine that may affect access, title, or the right or ability to perform work on the Property.

5.0 Accessibility, Climate, Local Resources, Infrastructure and Physiography

5.1 Accessibility

Sonora State has well developed infrastructure. An extensive network of roads, including a four-lane highway (Highway 15) that crosses the state from south to north, joins Sonora with the rest of Mexico and with the United States of America. The region is well known for cattle ranching, and ranches and fenced zones dot the area. The ranchers have created a network of secondary dirt roads to access other areas, and these roads provide excellent access to the Cajon deposit.

5.2 Climate and Physiography

The average ambient temperature is 21° C, with minimum and maximum temperatures of -5° C and 50° C, respectively in the deposit area. Extreme high temperatures, upwards of 49° C occur in summer while winters, although short, are cool comparable with most of Mexico. The accumulated annual rainfall for the area is approximately 450 millimetres. The wet season or desert “monsoon” season occurs between the months of July and September and heavy rainfall can hamper exploration at times. The Sonoran Desert, because of its bi-seasonal rainfall pattern, hosts plants from the agave, palm, cactus and legume family, as well as many others. The saguaro cactus, a protected species, is present in the concession area, but not near the Cajon deposit. Exploration work can be conducted year round.

The Cajon deposit is situated a desert climatic zone known as the Sonoran or “Gila” Desert (after the Gila River) an arid desert. The deposit lies between the Sierra La Ventana (west and southwest) and the Sierra La Madera (south and east) mountain ranges. These mountains vary in elevation, from ~1,360 m to ~ 2,045 m. The elevation in the valleys between the ranges varies from 730 m to 1,000 m. The Cajon deposit is located at the southeastern most portion of the Magdalena Project area where topographic relief is in the order of 100 metres.

5.3 Local Resources and Infrastructure

The main Ferro-Carril Pacifico Railway passes through the town of Magdalena de Kino and on to the state capital city of Hermosillo before connecting to the Port of Guaymas.

Two high voltage power lines traverse the northern part of the concession area and a natural gas pipeline, constructed in 1986, runs parallel to the electric lines.

Water is supplied to ranchers for irrigation and farming from the El Yeso River, which transects the region. A small block dam impounds water in the Magdalena Project area and creates a small lake, 75 ha in area, 6 km to the northwest of El Cajon. No other source of surface water is available. All water for exploration and mining activities must be pumped from wells. Ranch owners have been supportive in supplying sufficient water for drilling programs.

Availability of water for advanced exploration or mining has not been assessed. Other mining activity in the area, including silver and gypsum mining, has resulted in an influx of workers to the region, and has led to the development of a skilled labour pool.

The Company has agreements with owners of surface rights that provide the Company with sufficient surface rights for mining operations, including potential tailings storage and potential waste disposal areas and potential processing plant sites.

6.0 History

In 1964, US Borax, a subsidiary of the Rio Tinto Group, began exploration in Mexico and successfully discovered borate mineralization near the town of Magdalena de Kino in Sonora State. Following the initial discovery, US Borax, through Mexican subsidiaries and Joint Ventures, explored the surrounding area, known as the Magdalena Basin (Table 4).

Exploration efforts, including the drilling of 9 core holes into what is now referred to as the El Cajon deposit (Figure 3), continued until 2000. This work was successful in identifying several borate targets in the Magdalena Basin, including the TDO deposit (also known as the Unimin deposit) for which they completed several pilot plant metallurgy studies. All of the exploration to date on and in the vicinity of the Magdalena Project area was done by US Borax, its subsidiary or through Joint Venture agreements, thereby allowing the geological knowledge to be passed along without loss and the geological model to evolve from program to program. Minera Santa Margarita SA de CV (MSM), a Mexican registered subsidiary of US Borax – Rio Tinto, carried on the exploration campaigns begun by the Joint Venture partners, and in 2002 staked the San Francisco properties that now comprise the Bacanora's Magdalena Concessions. These claims were acquired in April 30th, 2008 by a royalty contract between the Bacanora's Mexican subsidiary Minera Sonora Borax SA de CV and MSM.

Table 4. Chronology of exploration in the Magdalena Project area

Year	Event
1969	First exploration for borates in Mexico by US Borax.
1972	Howlite found in Magdalena.
1976	Establishment of Materias Primas Magdalena (MPM) as JV between US Borax and Vitro
1977	MPM starts drilling in the Magdalena basin and discovers the Tinaja Del Oso Colemanite deposit (TDO)
1979-1985	Drilling continued in different parts of the basin
1980	Construction of the Magdalena Shaft at the TDO for metallurgical samples
1980	Installation of a Pilot Plant in Hermosillo by Vitro
1982-1986	Different tests and processes were conducted for the beneficiation of colemanite
1987-1990	Intense drilling, reserve calculation studies, construction of a second shaft (Kino Shaft) in the TDO area
1990	Completion of geologic, geotechnical studies in the TDO area
1991	Creation of Minera Santa Margarita by Rio Tinto in order to explore for industrial minerals in Mexico
1992	Dissolution of the USB-Vitro JV. Vitro paid \$US6 million to US Borax to maintain TDO
2002	Rio Tinto staked the San Francisco claims in the Magdalena Basin in order to evaluate the remaining borate potential
2003	First drilling campaign in Magdalena by MSM at Cajon and Bellota targets. Mapping and sampling

Table 4 continued. Chronology of exploration in the Magdalena Project area

Year	Event
2004	More drilling at Pozo Nuevo and Tigre targets. First gravity survey. Ground mag in the central portion of the basin
2005	Drilling at Pozo Nuevo and Escuadra targets. Complete gravity survey (610 stations)
2006	Reduction of land from 23k Ha to 12.6k Ha.
2007	Completion of geologic reports and economic exercises from TDO, Cajon and Pozo Nuevo targets
2008	Contract between MSM and MineraSonora Borax (MSB - Bacanora Minerals) to acquire the San Francisco claims.
2009	Completion of and submittal of a NI-43-101 Technical Report and Bacanora is listed on the with Tier 1 status on the TSX Venture Exchange.
2010	In-fill drilling at the Cajon Target by MineraSonora Borax.

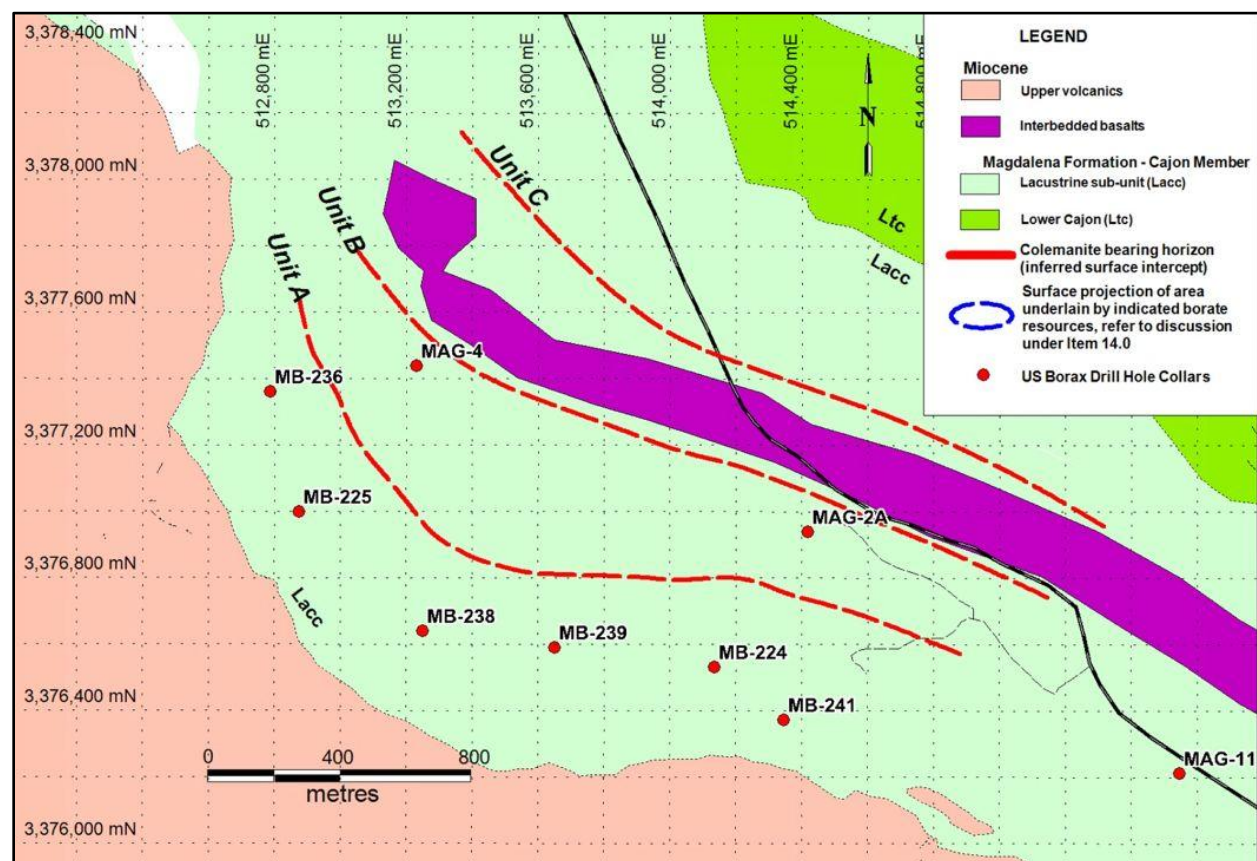
**Figure 3. Locations of US Borax drill holes on the El Cajon deposit**

There are no historical mineral resource or mineral reserve estimates in the area of the concessions.

There has been no mineral production from any of the concessions.

7.0 Geological Setting and Mineralization

7.1 Regional Geology

The geology of the Magdalena basin (Figure 4) is very complex due to its syn-kinematic origin and later geologic events that occurred in the region. In general, the basin is a topographic depression floored and surrounded by metamorphic and volcanic rocks. It has been recognized as the upper plate of the Magdalena-Madera metamorphic core complex (MCC). Both plates are separated by a major low-angle detachment fault. The lower plate is composed of two basement lithologies:

- 1) Metamorphic, composed of mylonites, gneisses and leucogranites and
- 2) Volcanic, composed of a latite flow

The upper plate is composed of three stacked gradational sedimentary sequences named from bottom to top: Bellota, Cajon and TDO. Every sequence hosts borate mineralization located in fine-grained fluvial-lacustrine successions. For the purpose of this report, only the Cajon sequence is described in detail (Figure 5).

Several basalt flows are interbedded within the sedimentary sequences with ages ranging from 22.6 to 21.4 Ma. A bimodal volcanic sequence dated in 20.6 Ma covers the basinal sediments marking the end of the basin development.

In general, fluvial-lacustrine sediments of the Magdalena basin were deformed by extensional tectonism. It is common to observe mudflows, turbidites, slumping breccias and “olistoliths” (big boulders composed of pre-basin rocks) cutting the sedimentary bedding. In addition, a series of anticlines and synclines as well as listric faults delimiting structural blocks are common structures along the basin. The associated borate mineralization is a product of diagenetic processes. All these features indicate that the Magdalena basin was syn-extensionally developed along with the neighboring metamorphic core complex. The basin’s development occurred during the period of 26.9 to 20.6 Ma (Eocene to Miocene, Miranda-Gasca et al., 1998).

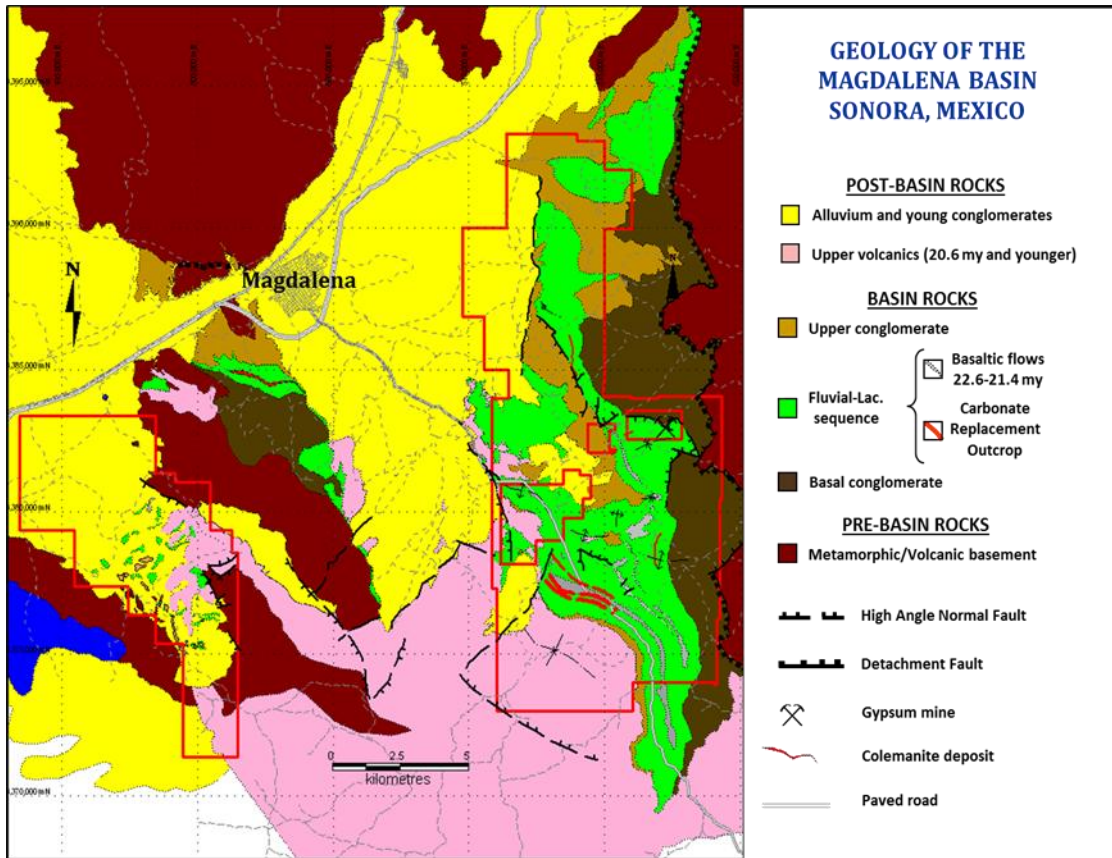

Figure 4. Geology of the Magdalena Basin and Project area

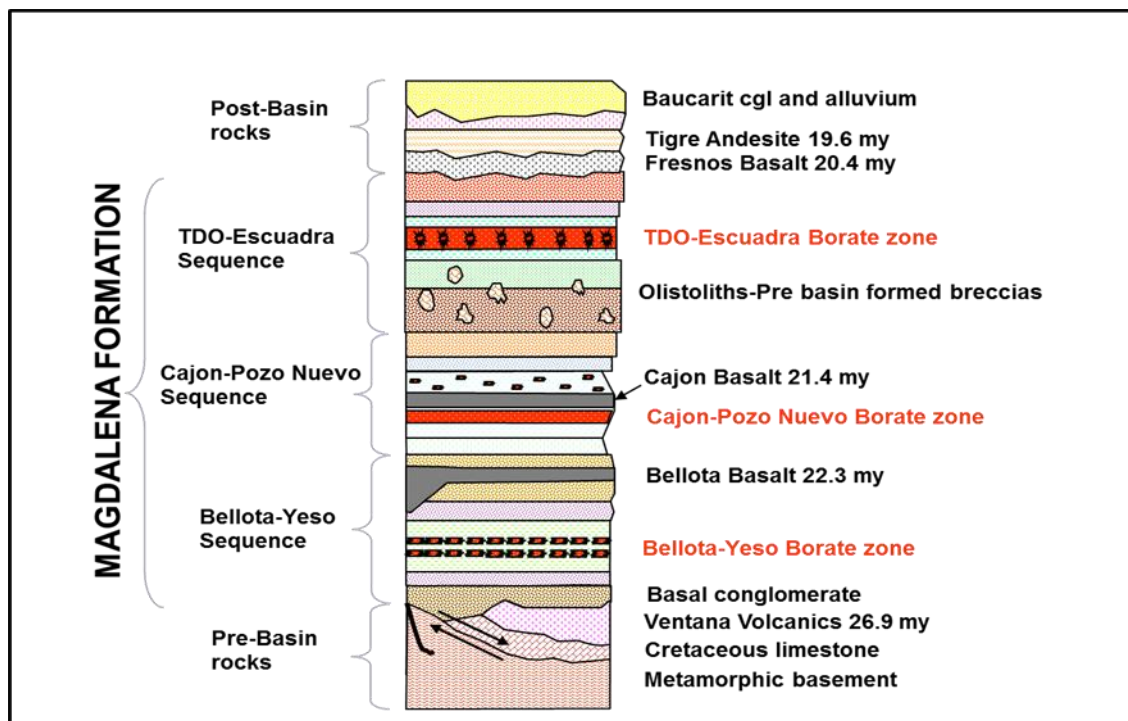

Figure 5. Stratigraphy of the Magdalena Basin

7.2 Property Geology

The Cajon borate deposit is situated stratigraphically in the Cajon-Pozo Nuevo sequence that is an intermediate sedimentary sequence in the Magdalena Formation (Figure 6) and overlies by depositional contact the Bellota-Yeso sequence. Structurally, the Cajon-Pozo Nuevo sequence has been folded into a series of open westward-plunging anticlines and synclines. It has been divided into four units, described in detail as follows:

Lower Cajon unit (Ltc)

This unit forms the base of the Cajon deposit and crops out immediately to the north of the deposit. It is composed of thin to medium bedded, tan and greenish, tuffaceous sandstone and siltstone with associated tuffs and tuffites. In fact, a yellowish lithic tuff has been observed in normal contact with the upper Bellota conglomerate. It changes laterally into tuffaceous sandstone. In the central area, it is in structural contact with the upper conglomerate from the Bellota sequence across a high angle normal fault. To the north, it is in normal contact with the Bellota basalt. Thickness varies from 170 to 250 m, being thicker in the central portion.

Fluvial-Lacustrine unit (Lacc)

This unit hosts the three colemanite-bearing zones that make up the Cajon borate deposit. It crops out across the central and western portions of the deposit area in transitional contact with the Lower Cajon unit. It is composed of thin to medium bedded, greenish, pink and light gray tuffaceous and calcareous mudstone with scarce siltstone and sandy horizons. Thickness varies from 200 to 600 m, being thicker in the south and central portions of the Cajon deposit area.

At surface this unit contains the carbonate replacement zones (CRZ) similar to those found at the TDO colemanite deposit and the Bellota sequence (UNIT C). Thickness of the CRZ's range from between 8 and 12 m. The CRZ horizons contain abundant calcite in masses and nodules with radial structures (pseudomorphs after colemanite), making them visually distinct at surface. Surface occurrences of CRZ contain scarce gypsum in veinlets; howlite and colemanite have also been reported. Geochemical anomalous boron and pathfinder elements are associated with the CRZ horizons.

The fluvial-lacustrine unit also contains an interbedded basaltic flow or sill called the "Cajon" basalt. It is composed of greenish-gray basalt with a characteristic diabasic texture. It is highly oxidized, gas-rich in some places with calcite filling cavities and fractures. Thickness roughly ranges from 40 up to 80 m, pinching out toward the southwestern portion and lensing out at the NW most portion of the target area.

No geochemical analyses from this flow have been reported. This flow has been dated at 21.4 ± 1.0 Ma and 21.8 ± 0.5 Ma by the K-Ar method (P. Dobbs, US Borax Internal report).

Upper transition unit (Utc)

This unit lies in the western and northwestern portions of the deposit area, in the vicinities of the "Yeso" water reservoir. It is composed of tan, highly calcareous, thin to medium bedded tuffaceous sandstone and siltstone with conglomeratic beds at the top. Thickness is approximately 150 m.

Upper conglomerate unit (Ucgc)

This unit crops out in the southern and western portions of the deposit area and unconformably overlies the Upper Transition unit. It is composed of a tuff matrix conglomerate containing abundant volcanic clasts, including amounts of “Cajon basalt” and occasional granitic fragments. The unit unconformably overlies the Cajon fluvial-lacustrine unit in the south, and it is unclear whether it really corresponds to the Magdalena Formation or is part of the post-basin units. Thickness varies from 30 to 50 m.

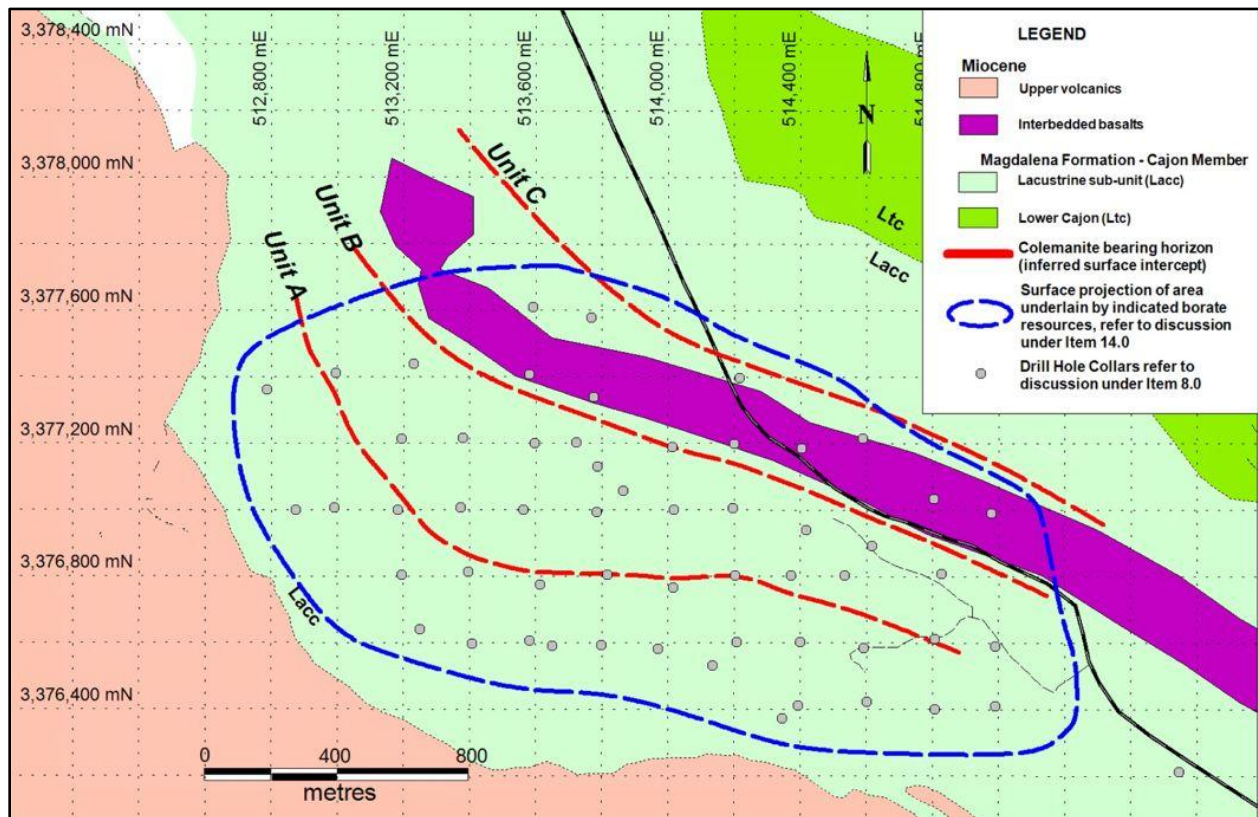

Figure 6. Surface geology of Cajon Deposit.

Units A, B and C are surface projections from drilling.

7.3 Mineralization

The Magdalena basin has principally been explored for borates, which occur there as the minerals colemanite ($\text{Ca}_2\text{B}_6\text{O}_{11} \cdot 5\text{H}_2\text{O}$) and howlite ($\text{Ca}_2\text{B}_5\text{SiO}_9(\text{OH})_5$) in bed-parallel, discontinuous, lenticular millimetre- to metre-scale layers interbedded within a gently to moderately dipping carbonaceous fluvial-lacustrine sedimentary sequence.

The concentration of mineralization is primarily affected by diagenetic processes responsible for the formation of enriched borate zones. Secondly, the grade of the mineralization is affected by leaching of the boron from the borates. Boron is stable in alkaline environments but is highly soluble in acidic conditions, such as at surface. Leaching of boron and replacement by calcite and other carbonates can result in distinctive carbonate replacement zones as a surface expression of underlying borate mineralization.

Due to the high solubility of boron, colemanite is usually altered to howlite, by adding silica, and calcite by replacing the borate radical by carbonate. In most borate deposits there is a geologic affinity between boron, lithium, strontium, arsenic and magnesium. These elements are frequently used as pathfinders during early stage boron exploration.

The aim of the exploration programs is to identify bulk-tonnage borate deposits with a proposed cut-off grade of 8% B₂O₃.

Borates in Magdalena

At least three pulses of borate mineralization are recognized in the Magdalena Project area. The first one occurred during a period of relative tectonic stability that allowed the deposition of the “Bellota” fluvial-lacustrine sequence and the first borate pulse. Another period of tectonism is recorded by the upper “Bellota” conglomerate and the “Bellota” basalt, dated in **22.3 ± 0.3 Ma** (Ar/Ar-whole rock) therefore, the lowermost borate mineralization occurred after the deposition of the Basal conglomerate and prior to the extrusion of the “Bellota” basalt between **24-23?** to **22.3 Ma**.

The second borate pulse is associated to a period of local stability but abundant volcanic activity in the region. The “Cajon” basalt is interbedded within the fluvial-lacustrine sequence and borates occur both beneath and above the basaltic flow. The “Cajon” basalt has been dated in **21.4 ± 1.0 Ma** (K-Ar).

After another period of tectonic instability, marked by the presence of boulders of pre-basin breccias and conglomerates, the youngest and more important borate mineralization occurred in the basin with the deposition of the Tinaja Del Oso in the west and Escuadra sequences in the northeast. No volcanic activity has been recorded during that period, but it can be bracketed between **21.4 ± 1.0 Ma** and **20.6 ± 0.1** which is the period between the deposition of the “Cajon” basalt and the reported age of the “Fresnos” basalt, which is the first post-basin unit that records the end of the Magdalena basin.

El Cajon Deposit

Borate mineralization at the El Cajon deposit consists primarily of colemanite and howlite. These minerals occur in three horizons: Units A, B and C. The units are situated within the Fluvial-Lacustrine member of the Cajon-Pozo Nuevo sequence (Table 5).

The mineralized units dip gently to moderately to the southwest. The thickness of units, estimated from drill intercepts, ranges for unit A from 2.13 to 4.6 metres and average 3.58 metres; for unit B from 3 to 7.6 metres and average 4.8 metres and for unit C from 2.36 to 10.56 metres, averaging 7.74 metres (Table 6). The units have been drill tested along a strike length of 2,200 metres and open on strike in either direction. The down dip extent of the mineralization tested by drilling is 900 metres and remains open at depth.

Petrographic analysis from nine drill core samples from units B and C of the Cajon deposit was conducted by Martin Vidal. The analysis indicated that for unit B colemanite occurs in individual semi-euhedral crystals (<1 mm in diameter), broken and partially replaced by calcite. Very small amounts of howlite were also noted. In Unit C colemanite occurs in howlite nodules. The howlite nodules themselves exhibit partial replacement by calcite.

Table 5. Fluvial-Lacustrine member of the Cajon-Pozo Nuevo sequence

Unit	Domain	Lithology	Description
US	USU		Brown claystone with minor siltstone and sandstone. Bedded to massive. Partly brecciated, with manganese oxides.
	USM		Slump breccia of mudstone and sandstone; gray with reddish spots (oxidation); abundant calcite in masses as borate alteration? Low recovery zone.
	USL		Rhythmic sequence composed of mudstone/sandstone/siltstone with manganese oxides. Bedded to massive. Minor gypsum at base. Calcareous. rarehowlite/calcite. Fractured.
A	A1		Mudstone breccia; colemanite (10%) in masses, partly altered to howlite; abundant calcite in masses.
	A2		Mudstone breccia; rare howlite nodules; abundant calcite in masses. Low grade zone.
	A3		Slump breccia; disseminated colemanite in masses and blebs; howlite in nodules.
RS	RS1		Rhythmic sequence composed of mudst/siltst/sst; bedded to masive; grayish-brown; locally brecciated; some borate mineralization.
	RS2		Mudstone breccia; brown; moderate gypsum with rare borate mineralization.
	RS3		Brown mudstone-siltstone-sandstone; rare gypsum and borate mineralization; partly bedded and brecciated to the bottom.
B	B1		Brown mudstone breccia; moderate gypsum; recrystallized colemanite; minor howlite
	B2		Green mudstone breccia; abundant gypsum; minor colemanite, rare howlite nodules.
SAB	MS		Mudstone (brownish-green) grading to sandstone to the bottom
	SS		Sandstone; massive, poorly bedded.
BAS	BAS		Cajon Basalt
LBS	LBS		Brown clays with iron oxides
C	C1		C High grade colemanite - upper
	C2		C Low Grade colemanite
	C3		C High grade colemanite - Lower
D	D		Lower Cajon - End of mineralization
E	E1		Fine-grained, chocolate coloured sandstone
	E2		Coarse sandstone

Table 6. Thickness and grade characteristics of the El Cajon Borate Deposit

Unit	Thickness		Average
	Minimum	Maximum	
A	2.13	4.6	3.58
B	3.0	7.6	4.8
C	2.36	10.56	7.74
Unit	Grade		Average
	Minimum	Maximum	
A	8.1	11.03	10.25
B	8.1	13.05	9.91
C	5.76	13.78	8.08

8.0 Deposit Types

8.1 Borate Deposits

Borate deposits can be divided into five main types (Barker and Lefond, 1985):

- 1) Precipitation from brines in a permanent or semi-permanent shallow lake or deep lake, known as lacustrine deposits. For this type of deposit to be formed the region must be arid, as borates have a high solubility. In addition, there must be an interior drainage system to concentrate the boron and minimize the dilution of boron from excess water, ions or sediment. Examples of this type of deposits include: Death Valley California and Bigadic, Turkey. This type of deposit produces most of the world's borates and is the most studied.
- 2) Crusts or crystals in mud of playas within near-surface sedimentary layers. These deposits are formed by repeated evaporation of incoming boron-bearing water by evaporation of groundwater. Repeated solution-crystallization cycles result in bedded borate strata. These types of deposits are found in Peru, Turkey and USA.
- 3) Direct precipitation near springs or fumaroles as a result of precipitation upon cooling of boron-bearing water and gases. This type of deposit is found in Italy, India and South America.
- 4) Evaporation of marine water such as in Germany and Russia. This type of deposit is usually very small and is most likely related to mining byproducts of evaporates and gypsum as opposed to naturally occurring.
- 5) Crystallization at or near granitic contacts or veins. Residual fluids associated with siliceous intrusions contain boron that is mobilized into the country rock through fluids. Boron may also be leached. No known deposits.

All borate deposits require that certain geological and environmental conditions were present. A borate deposit must have a source of water that contains anomalous amounts of dissolved borate. As well, a borate deposit must have a mechanism that transported the water to the site of deposition and prevented it from escaping to the sea. Finally, a borate deposit requires a geological process that was capable of concentrating the brine solutions to the point of borate crystallization. As the evaporation of seawater progresses, the deposition of borates from ulexite, colemanite and/or howlite will occur. The specific mineralogy of the borates deposited will depend on the ratio of boron to calcium and sodium in the water, as well as on any other elements (contaminants) present at the times of borate mineral precipitation.

Borate mineralization in the area of the Concessions is considered to be lacustrine in origin (Type 1) and is analogous to that found at Death Valley and the Bigadic deposits.

9.0 Exploration

Bacanora conducted diamond drilling campaign at El Cajon deposit in 2010. A total of 18 holes were drilled in order provide in-fill data between holes previously drilled by Rio Tinto the US Borax – Vitro Joint Venture. In 2011 a further 30 core holes were drilled into the deposit and in 2012,14 holes were completed as of the effective date of this report. Bacanora has conducted no other exploration on the Property.

Drill results from the 2010 and 2011 drill programs that Bacanora undertook, as well as the drill results from the US Borax drilling on the El Cajon deposit were used to estimate borate resources, as described in Item 14.0 of this report.

Details and results of Bacanora’s drilling are found in Section 10.0: *Drilling*.

10.0 Drilling

All of the drilling conducted to date on the El Cajon deposit has been undertaken by PerforacionesGodbe de Mexico SA de CV a Mexican subsidiary of Godbe Drilling LLC, based in Montrose, Colorado.

For each phase of drilling, drill core was moved from the drill sites by Bacanora personnel to a secure compound in Magdalena de Kino where it was logged, split and stored. In addition to logging of geological parameters in drill core, core recovery, recovery-of-broken intervals and rock quality designations were measured. Drill-hole collar locations were surveyed with an error of +/- 0.008 m. using a total station GPS, double-frequency Trimble R6 by Surveyor Hugo Maldonado of Topografía, Ingeniería y Dibujo SC.

The objective of the diamond drilling was to intersect the down dip expression of three outcropping carbonate replacement horizons (CRZ) with similar characteristics to the surface expression of the borate mineralization at the TDO colemanite deposit located in the western portion of the basin and the Pozo Nuevo prospect, which is another Bacanora borate target within the basin.

The relationship between sample length and the true thickness of the mineralization varies from 93% to 96% of sample length being equivalent to true thickness depending on the area of the deposit and the dip for the colemanite horizons at a particular intercept.

Drill core recovery was very close to 100% for the 2010, 2011 and 2012 drill programs. There are no sampling or recovery factors that could materially impact the accuracy of the results.

10.1 Drilling in 2010:

Bacanora’s first drilling campaign at the El Cajon deposit was conducted from May to September 2010.

A total of 1,984.6 m (6,511ft) using a NQ-core recovery diamond drilling technique were drilled in eighteen holes. Drill sites were laid out on a 200 metre grid (Figure 7).

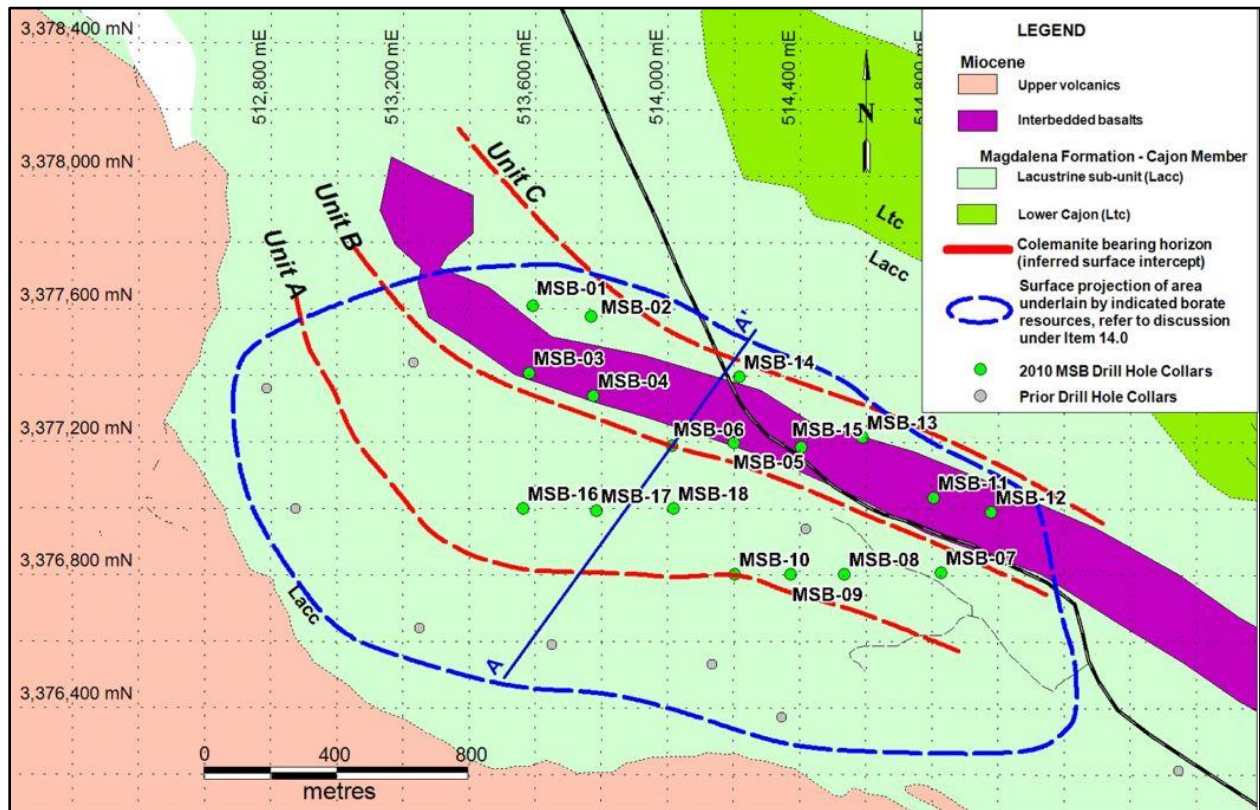

Figure 7. Drill hole location plan, 2010 and earlier holes, El Cajon Deposit

The drilling program successfully intersected predicted colemanite horizons. The interpretation of the colemanite-bearing horizons intersected by the drilling is that of three units dipping gently to the southwest (Figure 8). Significant borate assays (>5% B₂O₃) are listed below in Table 7.

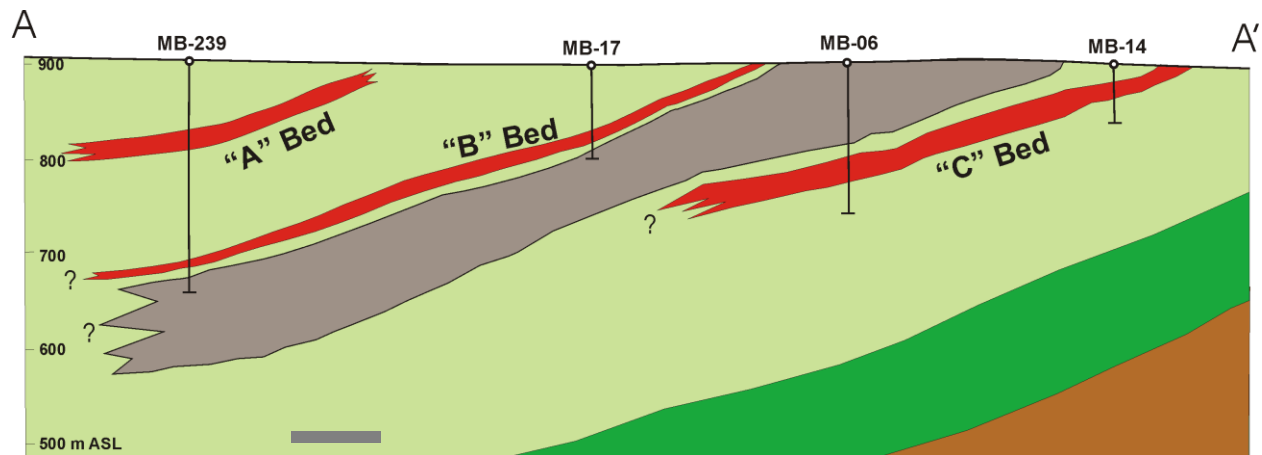

Figure 8. Geological Cross Section through the El Cajon Borate Deposit

Table 7. Significant Borate Drill Intercepts 2010 & MSM Programs, El Cajon Deposit

Hole No.	From (m)	To (m)	Interval (m)	B ₂ O ₃ %
MAG-2A	178.61	184.4	5.79	13.78
MB-224	249.63	252.68	3.05	8.4
MB-224	263.35	267.92	4.57	10.6
MB-225	81.99	86.56	4.57	10.53
MB-236	61.26	64.31	3.05	8.1
MB-239	73.76	78.33	4.57	11.03
MB-241	182.88	185.01	2.13	11
MSB-01	14.33	16.69	2.36	8.05
MSB-01	26.82	30.12	3.3	9.85
MSB-02	14.63	21.44	6.81	9
MSB-03	56.69	64.92	8.23	6.55
MSB-03	73.56	83.39	9.83	5.11
MSB-04	71.63	75.69	4.16	5.36
MSB-04	83.84	89.92	6.08	6.36
MSB-05	67.99	72.24	4.25	10.04
MSB-05	79.25	85.34	6.09	7.07
MSB-06	97.69	108.25	10.56	7.97
MSB-10	122.2	125.7	3.5	13.05
MSB-11	93.88	98.45	4.57	10.8
MSB-12	82.6	85.95	3.35	7.4
MSB-14	22.86	25	2.14	9
MSB-15	66.75	69.8	3.05	8.35
MSB-15	88.39	91.59	3.2	14.65
MSB-16	82.91	87.48	4.57	8.1
MSB-17	75.29	78.33	3.04	9.5

10.2 Drilling in 2011

In 2011, Bacanora completed 4,038 metres of drilling in 30 NQ sized core holes at the El Cajon deposit (Figure 9).

Drilling was carried out on the 200 metre square grid pattern initiated for the 2010 drill program. Significant borate assays from the 2011 drilling program are tabulated below (Table 8).

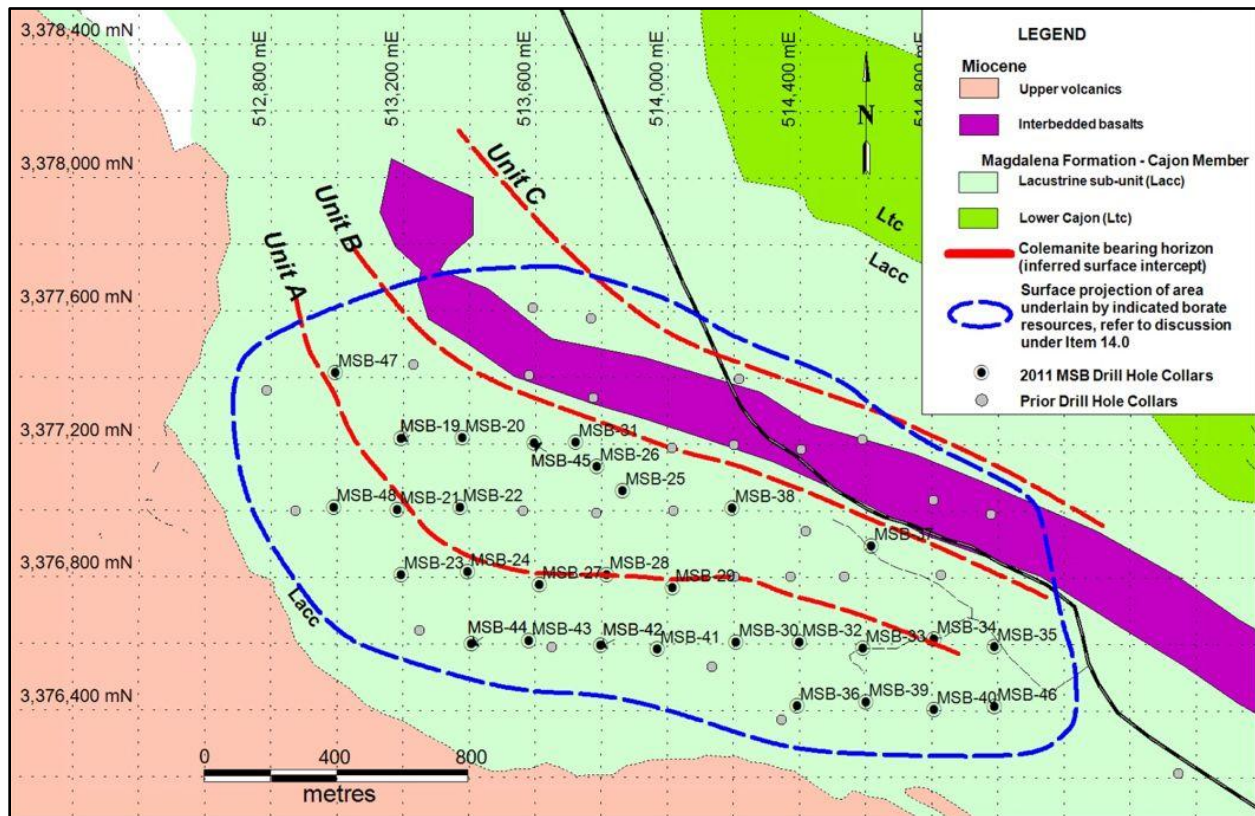

Figure 9. Drill hole location plan, 2011 and earlier holes, El Cajon Deposit

Table 8. Significant Borate Drill Intercepts 2011 program, El Cajon Deposit

Hole No.	From (m)	To (m)	Length (m)	B ₂ O ₃ %
MSB-20	47.17	48.77	1.6	7.41
MSB-21	31.7	34.14	2.44	6.70
MSB-21	34.14	35.36	1.22	5.89
MSB-21	124.36	125.27	0.91	5.80
MSB-22	106.07	107.59	1.52	5.41
MSB-23	75.72	77.42	1.7	5.02
MSB-23	78.94	80.47	1.52	10.53
MSB-23	80.47	81.99	1.52	12.17
MSB-23	81.99	83.52	1.52	8.31

Table 8 continued. 2011 program significant borate assays

Hole No.	From (m)	To (m)	Length (m)	B ₂ O ₃ %
MSB-23	96.01	97.54	1.52	9.79
MSB-23	97.54	98.76	1.22	9.72
MSB-23	208.79	210.31	1.52	6.02
MSB-23	211.84	213.36	1.52	5.31
MSB-24	52.73	54.25	1.52	5.60
MSB-24	54.25	55.78	1.52	12.36
MSB-24	55.78	57.3	1.52	6.28
MSB-24	174.24	175.56	1.32	7.82
MSB-24	175.56	177.09	1.52	6.92
MSB-25	43.28	44.81	1.52	14.65
MSB-25	44.81	46.33	1.52	10.63
MSB-25	46.33	47.85	1.52	8.05
MSB-25	49.38	50.6	1.22	6.79
MSB-25	61.26	62.79	1.52	7.21
MSB-26	25.83	27.13	1.3	8.08
MSB-26	27.13	28.65	1.52	5.92
MSB-27	33.22	34.75	1.52	9.92
MSB-27	34.75	36.27	1.52	7.50
MSB-27	39.32	40.84	1.52	5.73
MSB-27	164.29	165.81	1.52	9.47
MSB-27	168.86	170.38	1.52	5.15
MSB-28	127.41	128.63	1.22	8.69
MSB-28	139.29	140.82	1.52	10.72
MSB-29	151.18	152.7	1.52	12.72
MSB-29	152.7	154.23	1.52	11.43
MSB-30	59.74	60.96	1.22	8.11
MSB-30	62.18	63.29	1.12	5.86
MSB-30	72.24	73.76	1.52	8.86
MSB-30	73.76	74.98	1.22	5.54
MSB-30	74.98	76.2	1.22	8.98
MSB-30	76.2	77.72	1.52	9.63
MSB-30	85.04	86.26	1.22	5.70
MSB-30	87.58	88.7	1.12	5.70
MSB-30	88.7	90.22	1.52	9.72
MSB-30	90.22	91.74	1.52	6.89
MSB-30	91.74	93.27	1.52	5.64
MSB-30	93.27	94.79	1.52	6.96

Table 8 continued. 2011 program significant borate assays

Hole No.	From (m)	To (m)	Length (m)	B ₂ O ₃ %
MSB-30	94.79	96.32	1.52	8.89
MSB-30	216.71	218.24	1.52	6.67
MSB-30	218.24	219.76	1.52	9.50
MSB-30	229.51	230.73	1.22	10.01
MSB-30	230.73	231.95	1.22	9.63
MSB-30	231.95	233.17	1.22	15.10
MSB-30	233.17	234.39	1.22	8.53
MSB-30	246.58	248.11	1.52	5.02
MSB-32	52.12	53.64	1.52	13.14
MSB-32	53.64	55.17	1.52	8.18
MSB-32	64.31	65.84	1.52	13.01
MSB-32	65.84	67.36	1.52	10.05
MSB-32	67.36	68.58	1.22	8.89
MSB-32	68.58	69.8	1.22	13.14
MSB-32	69.8	71.02	1.22	10.95
MSB-33	48.16	49.38	1.22	6.57
MSB-33	49.38	50.9	1.52	9.95
MSB-33	50.9	52.43	1.52	10.50
MSB-33	181.36	182.88	1.52	6.50
MSB-33	195.07	196.6	1.52	7.21
MSB-33	196.6	198.12	1.52	13.43
MSB-34	127.1	128.32	1.22	11.11
MSB-34	142.04	143.26	1.22	9.18
MSB-34	143.26	144.48	1.22	12.36
MSB-34	144.48	145.69	1.22	22.54
MSB-34	145.69	146.91	1.22	13.46
MSB-35	84.73	86.26	1.52	5.31
MSB-36	152.4	153.92	1.52	5.80
MSB-36	153.92	155.45	1.52	6.25
MSB-36	158.5	160.02	1.52	6.60
MSB-36	160.02	161.54	1.52	5.28
MSB-36	164.59	166.12	1.52	6.15
MSB-36	166.12	167.64	1.52	11.14
MSB-36	167.64	169.16	1.52	7.21
MSB-36	175.26	176.78	1.52	10.05
MSB-36	176.78	178.31	1.52	6.60
MSB-36	178.31	179.83	1.52	7.79
MSB-36	179.83	181.05	1.22	9.63
MSB-36	303.89	305.41	1.52	8.24

Table 8 continued. 2011 program significant borate assays

Hole No.	From (m)	To (m)	Length (m)	B ₂ O ₃ %
MSB-36	305.41	306.93	1.52	5.47
MSB-36	317.6	319.13	1.52	6.34
MSB-36	319.13	320.65	1.52	5.60
MSB-36	320.65	322.17	1.52	5.60
MSB-36	335.89	337.41	1.52	5.67
MSB-39	131.06	132.66	1.6	11.37
MSB-39	134.42	135.94	1.52	5.60
MSB-39	142.19	143.56	1.37	8.18
MSB-39	143.56	145.08	1.52	9.02
MSB-39	145.08	146.61	1.52	13.40
MSB-39	146.61	148.13	1.52	7.63
MSB-39	151.18	152.7	1.52	9.76
MSB-39	152.7	154.23	1.52	9.76
MSB-39	154.23	155.75	1.52	12.33
MSB-39	155.75	157.28	1.52	11.85
MSB-39	157.28	159.03	1.75	11.85
MSB-40	93.27	94.79	1.52	5.83
MSB-40	96.32	97.84	1.52	5.54
MSB-40	97.84	99.36	1.52	6.86
MSB-40	99.36	100.89	1.52	10.56
MSB-40	106.68	107.9	1.22	6.44
MSB-40	109.42	110.95	1.52	6.34
MSB-40	110.95	112.47	1.52	9.53
MSB-40	114	115.21	1.22	7.41
MSB-40	115.21	116.43	1.22	7.86
MSB-40	116.43	117.65	1.22	13.14
MSB-40	117.65	118.87	1.22	9.63
MSB-40	118.87	120.4	1.52	5.06
MSB-40	120.4	121.92	1.52	6.96
MSB-40	123.14	124.36	1.22	5.89
MSB-40	124.36	125.88	1.52	9.21
MSB-40	125.88	127.41	1.52	15.94
MSB-40	127.41	128.93	1.52	13.33
MSB-40	128.93	130.45	1.52	20.54
MSB-40	130.45	131.67	1.22	10.24
MSB-40	131.67	132.89	1.22	8.05
MSB-41	75.29	76.81	1.52	7.92
MSB-41	81.08	82.3	1.22	6.86
MSB-41	82.3	83.52	1.22	12.88

Table 8 continued. 2011 program significant borate assays

Hole No.	From (m)	To (m)	Length (m)	B ₂ O ₃ %
MSB-41	83.52	84.73	1.22	13.72
MSB-41	87.78	89.31	1.52	5.41
MSB-41	92.35	93.88	1.52	9.21
MSB-41	93.88	95.1	1.22	7.15
MSB-41	96.47	97.84	1.37	9.89
MSB-41	97.84	99.36	1.52	12.20
MSB-41	99.36	100.89	1.52	5.60
MSB-41	100.89	102.41	1.52	8.40
MSB-41	102.41	103.94	1.52	5.12
MSB-42	75.9	77.42	1.52	6.54
MSB-42	77.42	78.94	1.52	8.82
MSB-42	78.94	80.77	1.83	14.84
MSB-42	87.48	89	1.52	8.47
MSB-42	90.53	92.05	1.52	8.28
MSB-42	92.05	93.57	1.52	13.75
MSB-42	93.57	95.1	1.52	6.21
MSB-42	96.32	97.54	1.22	6.21
MSB-43	84.73	86.26	1.52	5.28
MSB-43	87.78	89.31	1.52	9.40
MSB-43	89.31	90.63	1.32	13.49
MSB-44	123.75	125.27	1.52	5.35
MSB-44	125.27	126.8	1.52	11.14
MSB-44	126.8	128.32	1.52	15.33
MSB-45	26.21	27.74	1.52	12.11
MSB-45	27.74	29.26	1.52	7.66
MSB-45	32.31	33.83	1.52	7.50
MSB-46	35.05	36.58	1.52	8.57
MSB-46	40.84	42.37	1.52	15.55
MSB-46	42.37	44.2	1.83	8.53
MSB-46	44.2	45.72	1.52	15.01
MSB-46	45.72	47.55	1.83	17.42
MSB-48	63.7	65.23	1.52	5.86
MSB-48	66.75	68.28	1.52	12.46
MSB-48	68.28	69.8	1.52	7.86
MSB-48	69.8	71.63	1.83	8.98
MSB-48	82.6	84.12	1.52	6.28

10.3 Drilling in 2012

In 2012, Bacanora completed 1,147 metres of drilling in 14 NQ sized core holes at the El Cajon deposit (Figure 10). The 2012 drill results have not been included or used in estimating borate resources in Item 14.0 of this report.

The drilling consisted of a series of in-fill holes placed between exiting drill holes. The holes only drilled into unit A in order to improve the resource estimate for this unit. Significant borate assays from the 2012 drilling program are tabulated below (Table 9).

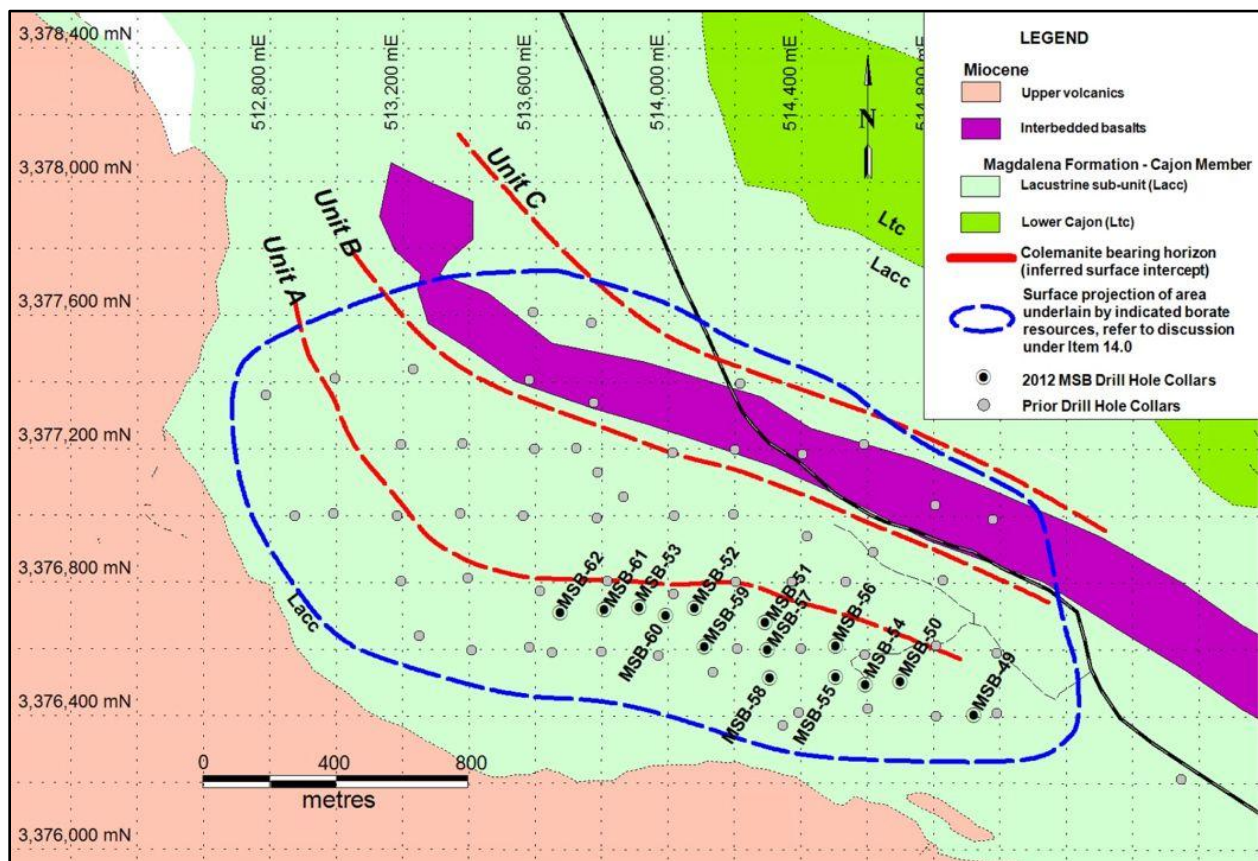

Figure 10. Drill hole location plan, 2012 and earlier holes, El Cajon Deposit

Table 9. Significant Borate Drill Intercepts 2012 program, El Cajon Deposit

Hole No.	From (m)	To (m)	Length (m)	B ₂ O ₃ %
MSB-50	71.32	73.15	1.83	8.53
MSB-50	81.08	84.12	3.05	18.48
MSB-50	84.12	86.26	2.13	12.26
MSB-51	35.36	38.40	3.05	6.25
MSB-51	38.40	39.62	1.22	11.32
MSB-52	22.56	24.69	2.13	13.07
MSB-52	27.74	28.96	1.22	9.19
MSB-53	33.53	35.05	1.52	5.56
MSB-53	38.10	39.62	1.52	21.20

Table 9 continued. 2012 program significant borate assays

Hole No.	From (m)	To (m)	Length (m)	B ₂ O ₃ %
MSB-54	76.50	78.03	1.52	6.05
MSB-54	87.17	88.70	1.52	8.23
MSB-54	88.70	90.22	1.52	7.61
MSB-54	90.22	91.74	1.52	5.44
MSB-54	99.36	100.89	1.52	9.48
MSB-54	100.89	102.41	1.52	7.63
MSB-54	102.41	103.94	1.52	8.68
MSB-54	103.94	105.46	1.52	9.74
MSB-54	111.56	113.08	1.52	12.95
MSB-54	113.08	114.60	1.52	10.04
MSB-54	114.60	116.13	1.52	12.05
MSB-54	116.13	117.81	1.68	12.91
MSB-55	74.68	76.20	1.52	5.08
MSB-55	83.82	85.34	1.52	8.35
MSB-55	85.34	87.17	1.83	5.38
MSB-55	96.32	97.84	1.52	6.15
MSB-55	97.84	99.36	1.52	10.30
MSB-55	99.36	100.89	1.52	6.64
MSB-55	100.89	102.41	1.52	15.55
MSB-55	110.03	111.56	1.52	10.84
MSB-55	111.56	113.08	1.52	10.44
MSB-55	113.08	114.60	1.52	9.11
MSB-55	114.60	115.82	1.22	16.40
MSB-55	115.82	117.04	1.22	10.86
MSB-56	29.26	30.78	1.52	5.83
MSB-56	30.78	32.31	1.52	5.71
MSB-56	47.85	49.38	1.52	7.74
MSB-56	49.38	50.90	1.52	11.02
MSB-56	50.90	52.43	1.52	5.98
MSB-56	52.43	53.80	1.37	10.30
MSB-57	46.63	48.16	1.52	5.25
MSB-57	48.16	49.68	1.52	5.09
MSB-57	49.68	51.21	1.52	5.04
MSB-57	55.60	57.00	1.40	9.11
MSB-57	57.00	58.22	1.22	9.37
MSB-57	58.22	59.44	1.22	6.63
MSB-57	62.48	64.92	2.44	5.53
MSB-57	70.00	71.63	1.62	12.14
MSB-57	71.63	73.15	1.52	10.76
MSB-57	73.15	74.68	1.52	12.28
MSB-57	80.77	82.30	1.52	8.56
MSB-57	83.82	85.34	1.52	9.43
MSB-57	85.34	86.87	1.52	15.02
MSB-57	86.87	88.39	1.52	8.99
MSB-57	88.39	89.92	1.52	9.13

Table 9 continued. 2012 program significant borate assays

Hole No.	From (m)	To (m)	Length (m)	B ₂ O ₃ %
MSB-57	89.92	91.14	1.22	15.61
MSB-59	64.31	65.84	1.52	7.23
MSB-59	75.29	76.81	1.52	8.32
MSB-59	78.33	79.86	1.52	10.52
MSB-59	79.86	81.38	1.52	14.24
MSB-59	87.48	89.00	1.52	6.10
MSB-59	89.00	90.53	1.52	5.52
MSB-59	90.53	92.05	1.52	8.00
MSB-59	92.05	93.57	1.52	7.25
MSB-59	93.57	95.10	1.52	8.96
MSB-59	95.10	96.62	1.52	9.51
MSB-59	96.62	98.15	1.52	6.92
MSB-59	98.15	99.67	1.52	5.73
MSB-60	32.31	33.83	1.52	6.78
MSB-60	35.36	38.40	3.05	9.69
MSB-60	38.40	39.93	1.52	5.61
MSB-60	39.93	41.45	1.52	9.44
MSB-60	42.98	44.50	1.52	9.19
MSB-61	25.30	26.82	1.52	6.67
MSB-61	26.82	28.65	1.83	15.07
MSB-61	35.97	37.49	1.52	13.24
MSB-61	40.54	42.37	1.83	5.64
MSB-62	36.88	38.71	1.52	13.11
MSB-62	38.71	39.93	1.52	5.03
MSB-62	46.94	48.46	1.52	5.81
MSB-62	51.51	53.04	1.52	12.19
MSB-62	53.04	54.56	1.52	6.40

11.0 Sample Preparation, Analyses and Security

A total of 1,569 samples were obtained by splitting the core in half with a manual core splitter for drill core from the 2010 and 2011 programs. One half was sent for assays and the remaining half retained for future analysis. The samples have a standard length of 1.52 metres (5 ft), except on the geologic contacts where the length is adjusted to the contact. For the El Cajon drilling campaign, an average length of was 1.52 m per sample was obtained from a total of 2,386 m of core.

The samples were bagged and labeled with a sequential unique sample identification number. Mr. Martin Vidal, Vice-President of Exploration for Bacanora Minerals Ltd supervised the core sampling.

Split drill core samples from the 2010 program were shipped to an SGS Laboratories sample preparation facility in Durango, Mexico for preparation. Prepared sample pulps were then shipped to SGS Minerals Research Limited in Lakefield, Canada, for assay and analysis. SGS Lakefield research is an ISO 14001-2004 certified laboratory in Canada and its preparation facility in Mexico has received ISO 17025 certification.

Sample preparation was conducted according to the regular SGS commonly used rock, drill core and chip sample procedures which consist of crushing the sample to - 5 mm sized material, splitting off 250gm of that and pulverizing the split sample to better than 85% passing through a 75 micron aperture screen.

All samples were analysed by full ICP-OES method in a suite of 32 elements (Ag, Al, As, B, Ba, Be, Bi, Ca, Cd, Co, Cr, Cu, Fe, K, Li, Mg, Mn, Mo, Na, Ni, P, Pb, Sb, Se, Sn, Sr, Tl, Ti, U, V, Y, Zn; present in ppm). In addition, a borate assay was determined by colourimetric titration methods on an aqua regia digested sample solution. The value determined from titration was converted into percent borate using the formula: $B_2O_3 = (B \times 3.22)$.

For the 2011 program drill core samples were shipped to ALS Chemex in Vancouver for analysis by ICP_OES method. Pulps from samples with boron values greater than 10,000 ppm were sent to SGS for boron assay by titration. ALS Chemex is a part of the ALS Group which is a wholly owned subsidiary of Campbell Brothers Limited, a publicly listed Australian Company. The ALS Group has ISO 9001:2008 registration and ISO 17025 accredited methods in North America.

In addition, assaying for boron by titration methods by Laboratorio Técnico Metalurgico SA de CV ("LTM") of Hermosillo, Mexico is being conducted on some of the 2011 and 2012 samples as a part of the quality control and quality assurance for samples being used in metallurgical test work. LTM does not have ISO registration or ISO accreditations LTM was founded and is operated under the guidance of Hector Diaz, PhD, who previously taught metallurgy at the University of Sonora. The QPs' are of the opinion that the work of LTM is reliable for the purposes of this report.

The chart below (Figure 11) illustrates the general work flow for the handling, treatment and analysis on which the Bacanora core samples can be tested.

Boron Samples Workflow

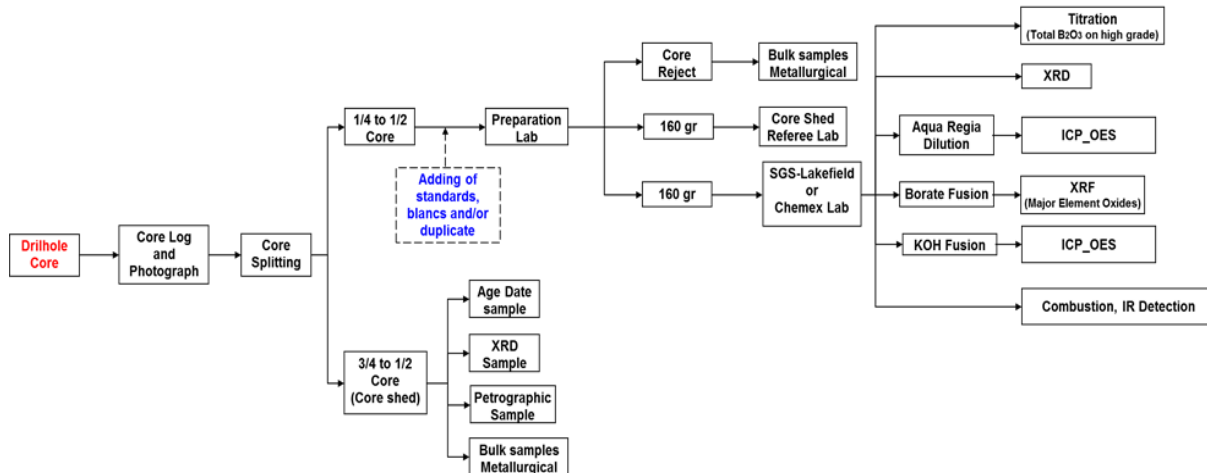

Figure 11. Flow chart of core sample handling

As part of an internal Quality Assurance/Quality Control protocol, two in-house standards were prepared and inserted on average every 20th sample. In addition, 58 duplicate analyses were performed by the laboratory as their own internal quality control.

The in-house standards consisted of a boron deficient sample (Standard TT) and a high boron sample (Standard MYTT). Standard TT was collected from a boron deficient, tuffaceous clay horizon that has been used as a marker bed in the borate-bearing Tubutama basin in Sonora, Mexico. Standard MYTT is composed of a mixture of boron bearing clay from the Magdalena basin (yeso mine) and non-boron bearing tuff (marker bed) from the Tubutama basin, Sonora, Mexico. Analyses of the standards are found in Table 10, below.

The in-house standards were prepared at LTM facilities in Hermosillo. Approximately 50 kg of each sample was bulk milled to <100 μ m and homogenized in a single batch in a drum mixer for 24 hours. Approximately 100 gram sub-samples were then split from the standard and sealed in plastic bags ready for insertion into sample batches.

Analytical ranges were determined from 3 laboratories (SGS-Lakefield, ALS-Chemex and University of Sonora) with additional analytical data collected in other projects were the same standards were used to refine the precision of the standards. For this work minimum and maximum accepted values from mean are $\pm 10\%$.

Table 10. Analyses of Bacanora Boron standards

	Values	B ppm	As ppm	Ca ppm	Li ppm	Mg %	Sr ppm
Standard TT	Average	18	19	3.0	231	0.9	9,916
	Max	79	22	3.3	260	1.0	11,000
	Min	4	16	2.7	200	0.9	5,000
	StdDev	15.4	2.4	0.14	13.2	0.04	1,813
Standard MYTT	Average	8,654	188	12.35	172.3	0.623	3,758
	Max	10,000	215	13.6	217	0.68	4,480
	Min	7,520	161	11.0	130	0.55	3,320
	StdDev	461.2	9.9	0.492	18.38	0.026	255.6

From the QA/QC analysis it was determined that most elements correlate well with the standards, only randomly picked samples seem to be out of range without any marked tendency.

In the first holes, a case of possible systematic error in boron analyses occurred with three consecutive samples. The problem was fixed with the re-assaying of several samples. This might be an effect of the known high solubility of boron, especially at low concentration levels. Strontium is over-estimated for Standard TT, since most samples are above the value set for the standard. However, this might be due the fact that there is a maximum detection limit with 11,000 ppm for Sr.

In the QPs' opinion sample preparation, security and analytical procedures were adequate for this stage of exploration and comply with industry best practices.

12.0 Data Verification

As part of the data verification process Qualified Person, Carl Verley, P.Geo. has:

1. examined drill sites on the El Cajon project site, and found the sample of holes examined to be as represented in terms of location;
2. examined drill core from the project, including intersection of colemanite-bearing sediments and found this to be as represented in drill log descriptions;
3. examined the drill in operation drilling the El Cajon deposit, and found this to be operated in a safe and effective manner with excellent core recovery;
4. examined the drill core storage facilities and core stored therein at Magdalena de Kino and found these to be secure and well maintained;
5. examined assay certificates from SGS and ALS Chemex in order to ascertain the veracity of drill assay and analytical data and found these to be in order;
6. examined drill logs and drill sections and found these to be in order and to fairly and accurately represent the material drilled and logged.

In addition, Qualified Person, Geoff Allard, P.Eng. has sampled and tested the material in the drill core and has been able to verify the presence of colemanite in the core in the concentrations typical of those presented in the assay and analytical data.

Qualified Person Ramon Salazar Velazquez, Lic. Eng. has validated the drill hole and analytical data with QA/QC tools in order to detect depth inconsistencies, overlaps or gaps in the sampling and lithological logs.

The Qualified Persons are satisfied that data used and generated by Bacanora during the course of its work on El Cajon are adequate for the purposes used in this report.

13.0 Mineral Processing and Metallurgical Testing

The current laboratory or bench-scale test-work has been performed by Minera Sonora Borax staff at LTM in Hermosillo under the direction of Geoff Allard, P.E. since 1 December 2011. To date these tests have consisted of thirty six separate investigations into scrubbing/de-sliming; flotation and calcining. Over 1,952 assays were performed in conjunction with these tests.

Laboratory testing has identified a suitable process consisting of a combination of scrubbing, de-sliming and flotation to obtain a concentrate in the range of 38% to 42% B₂O₃ in batch flotation tests from a nominal feed of 10.5% B₂O₃. Overall recovery of 80% to 90% of contained B₂O₃ in the feed has been demonstrated.

13.1 Test Composites:

Metallurgical investigations were based on two composites (2A and 3A) for the “A” zone of the Cajon deposit as identified in Tables 11 and 12 and in Figure 12.

Table 11. Drill Core Selection for Composite 2A.

HoleNo	Sample No.	Sample ID	From (m)	To (m)	Length (m)	As (ppm)	B ₂ O ₃ %
MSB-36	MSB-36-28	BM01953	175.26	176.78	1.52	444	10.0%
MSB-36	MSB-36-29	BM01954	176.78	178.31	1.52	329	6.6%
MSB-36	MSB-36-30	BM01955	178.31	179.83	1.52	334	7.8%
MSB-36	MSB-36-31	BM01956	179.83	181.05	1.22	381	9.6%
MSB-39	MSB-39-29	BM02076	154.23	155.75	1.52	534	12.3%
MSB-39	MSB-39-30	BM02077	155.75	157.28	1.52	470	11.8%
MSB-39	MSB-39-31	BM02078	157.28	159.03	1.75	425	11.8%
MSB-40	MSB-40-33	BM02116	125.88	127.41	1.52	732	15.9%
MSB-40	MSB-40-34	BM02117	127.41	128.93	1.52	595	13.3%
MSB-40	MSB-40-35	BM02118	128.93	130.45	1.52	986	20.5%
MSB-40	MSB-40-36	BM02119	130.45	131.67	1.22	633	10.2%
MSB-40	MSB-40-37	BM02120	131.67	132.89	1.22	418	8.0%
MSB-41	MSB-41-30	BM02159	99.36	100.89	1.52	153	5.6%
MSB-41	MSB-41-31	BM02160	100.89	102.41	1.52	228	8.4%
MSB-41	MSB-41-32	BM02161	102.41	103.94	1.52	137	5.1%
MSB-41	MSB-41-33	BM02162	103.94	105.46	1.52	164	4.9%
MSB-42	MSB-42-24	BM02190	90.53	92.05	1.52	230	8.3%
MSB-42	MSB-42-25	BM02191	92.05	93.57	1.52	367	13.7%
MSB-42	MSB-42-26	BM02192	93.57	95.1	1.52	182	6.2%
MSB-44	MSB-44-12	BM02222	123.75	125.27	1.52	148	5.3%
MSB-44	MSB-44-13	BM02223	125.27	126.8	1.52	302	11.1%
MSB-44	MSB-44-14	BM02224	126.8	128.32	1.52	430	15.3%
MSB-46	MSB-46-12	BM02259	40.84	42.37	1.52	885	15.6%
MSB-46	MSB-46-13	BM02260	42.37	44.2	1.83	924	8.5%
MSB-46	MSB-46-14	BM02261	44.2	45.72	1.52	951	15.0%
MSB-46	MSB-46-15	BM02262	45.72	47.55	1.83	805	17.4%
MSB-48	MSB-48-06	BM02270	68.28	69.8	1.52	128	7.9%
MSB-48	MSB-48-07	BM02271	69.8	71.63	1.83	171	9.0%
Average:					1.53	449	10.6%

Table 12. Drill Core Selection for Composite 3A.

Hole No	Sample No.	Sample ID	From (m)	To (m)	Length (m)	As (ppm)	B2O3 %
MSB-30	MSB-30-17	BM01648	59.74	60.96	1.22	284	8.1%
MSB-30	MSB-30-38	BM01670	88.7	90.22	1.52	353	9.7%
MSB-36	MSB-36-21	BM01946	164.59	166.12	1.52	276	6.1%
MSB-36	MSB-36-22	BM01947	166.12	167.64	1.52	463	11.1%
MSB-36	MSB-36-23	BM01948	167.64	169.16	1.52	316	7.2%
MSB-39	MSB-39-14	BM02060	131.06	132.66	1.6	507	11.4%
MSB-39	MSB-39-21	BM02068	142.19	143.56	1.37	395	8.2%
MSB-39	MSB-39-22	BM02069	143.56	145.08	1.52	379	9.0%
MSB-39	MSB-39-23	BM02070	145.08	146.61	1.52	550	13.4%
MSB-39	MSB-39-24	BM02071	146.61	148.13	1.52	348	7.6%
MSB-39	MSB-39-27	BM02074	151.18	152.7	1.52	421	9.8%
MSB-39	MSB-39-28	BM02075	152.7	154.23	1.52	456	9.8%
MSB-41	MSB-41-28	BM02157	96.47	97.84	1.37	295	9.9%
MSB-41	MSB-41-29	BM02158	97.84	99.36	1.52	377	12.2%
MSB-42	MSB-42-15	BM02180	77.42	78.94	1.52	240	8.8%
MSB-42	MSB-42-16	BM02181	78.94	80.77	1.83	459	14.8%
MSB-42	MSB-42-22	BM02188	87.48	89	1.52	231	8.5%
MSB-43	MSB-43-05	BM02205	87.78	89.31	1.52	245	9.4%
MSB-43	MSB-43-06	BM02206	89.31	90.63	1.32	426	13.5%
MSB-48	MSB-48-05	BM02269	66.75	68.28	1.52	298	12.5%
Average:					1.50	374	10.2%

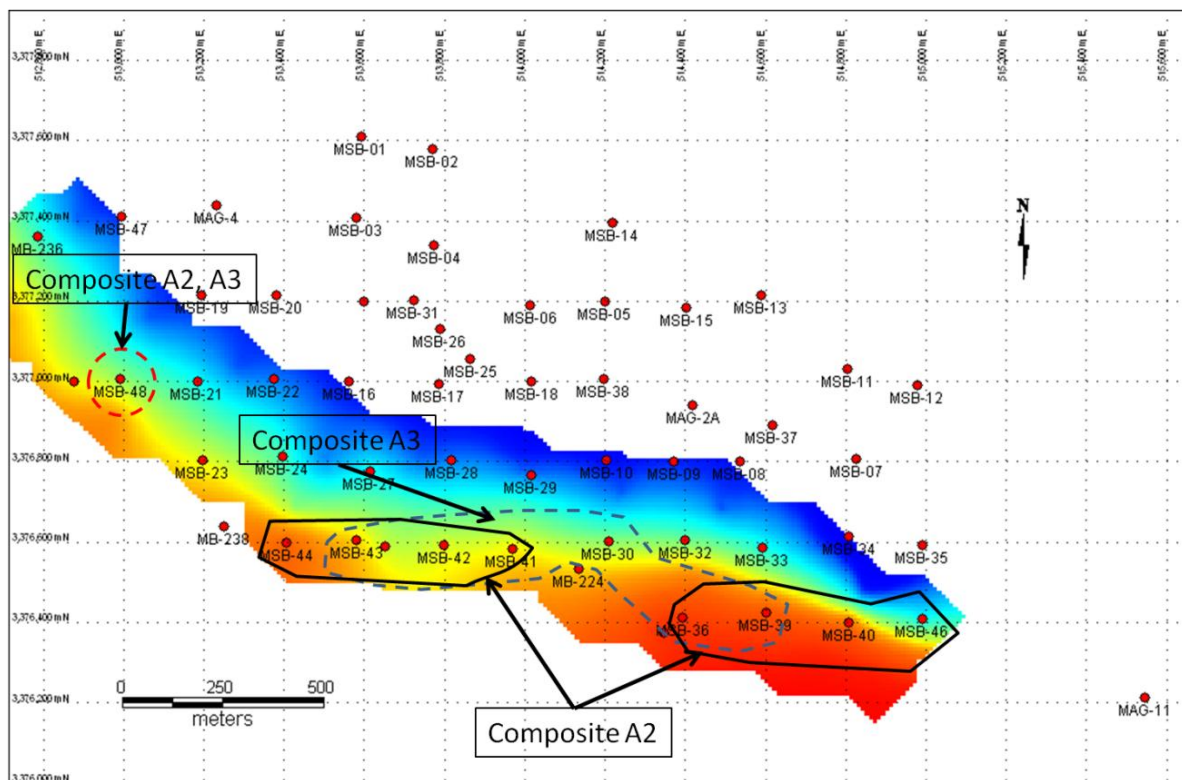

Figure 12. Location Map of Drill Holes Comprising Composites A2 and A3.

13.2 Scrubbing/De-sliming:

Lacustrine colemanite deposits are intimately associated with fine plastic clays. These clays are inter-bedded and perhaps inter-crystalline reducing the apparent B_2O_3 concentration of the colemanite. This behavior of the clays is also observed in the Cajon deposit. Removing the clays, predominantly montmorillonite, from the feed is critical to successfully upgrading the colemanite. Scrubbing tests were performed to determine the quantity of clays that can be removed and the attendant loss of B_2O_3 . The tests indicated multiple steps of scrubbing followed by de-sliming at 325 mesh are required to liberate the colemanite from the clays.

Two stages of scrubbing were identified as optimal. The first stage is to tumble the coarse feed in a wet trommel scrubber to disperse the large clay masses and liberate the coarse, competent rock particles. The discharge of the trommel scrubber is screened into fine (minus 6.3 mm) material and coarse (plus 6.3mm) material. The fine material is de-slimed at 45 microns (325 mesh) and attrition scrubbed. The coarse material is crushed to minus 6.3 mm and attrition scrubbed. The attrition scrubbing of the de-slimed products comprise the second stage. The two materials are attrition scrubbed separately because test-work showed that optimal scrubbing for each material required different residence times. The second stage attrition scrubbed material is recombined and de-slimed at 45 microns (325 mesh). Table 13 shows the typical loss of weight and B_2O_3 to the slimes fractions after each scrubbing stage for Composite 2A and 3A.

Table 13. Mass and B_2O_3 from Feed Reporting to Slimes.

Composite		Trommel. Scrub		Fine Scrub		Coarse Scrub		Total Reporting to Slimes		
		Wt% Feed	B_2O_3 % Feed	Wt% Feed	B_2O_3 % Feed	Wt% Feed	B_2O_3 % Feed	Wt% Feed	B_2O_3 % Feed	Assay B_2O_3 %
2A (35 Tests)	Average	19.36%	4.61%	9.29%	2.93%	14.83%	6.17%	45.52%	14.49%	3.60%
	StdDev	3.38%	1.35%	3.33%	1.28%	3.56%	2.10%	4.04%	2.88%	0.57%
3A (24 Tests)	Average	16.39%	2.48%	8.10%	1.71%	19.06%	6.83%	43.55%	11.01%	2.66%
	StdDev	1.89%	0.52%	1.76%	0.64%	3.13%	0.91%	3.82%	1.58%	0.45%

As can be seen from Table 13 slightly less than half of the feed is rejected by desliming while retaining 85% to 89% of the B_2O_3 . Table 1 also shows that each scrub stage contributes to the removal of gangue from the feed to flotation.

Composite 2A shows a slightly higher B_2O_3 loss which may be due to crushing the bulk composite to passing 19 mm. Composite 3A was slightly coarser, 100% passing 25 mm. Scrubbing improves the B_2O_3 concentration of the feed to flotation with minimal loss to the slimes. Typical feed to flotation is presented in Table 14.

Table 14. Typical Feed to Rougher Flotation.

	2A	3A
No.	8	14
Average	20.19%	16.60%
Max	22.66%	19.48%
Min	18.55%	14.27%
StdDev	1.17%	1.76%
COV	5.81%	10.62%

13.3 Flotation:

Extensive flotation tests were performed using conventional and non-conventional flotation collectors. Optimum results were obtained using a non-conventional di-alkyl sulfo-succinate as collector. A combination of bulk rougher flotation followed by two stages of cleaner flotation stages was found to be optimal. An additional discovery was that fine grinding after de-sliming and intense attrition scrubbing of the concentrates before each cleaner stage improves the grade. Recovery with the sulfo-succinate collector is high in each stage. Tables 15 and 16 show typical data for two stages of cleaning for Composites 2A and 3A. At the time of these tests the bulk of Composite 2A had been consumed by testing. Minus ¼” rejects from the core assays were combined to re-create Composite 2A. Since the material was finer the coarse attrition scrub was not possible.

Table 15. Typical Batch Flotation Response for Composite 2A (rejects).

FL025.3 Mass Balance	Wt. gms	Wt % at Size	Cum. Weight%	Assay B ₂ O ₃ %	B ₂ O ₃ gms	B ₂ O ₃ % of Feed	Cum. B ₂ O ₃ Recovered
2nd Cleaner Concentrate:	548.6	24.80%	24.80%	35.9%	197.15	77.17%	77.17%
2nd Cleaner Tail:	23.1	1.04%	25.85%	12.4%	2.87	1.13%	78.29%
1st Cleaner Tails:	97.3	4.40%	30.25%	3.6%	3.48	1.36%	79.66%
Rougher Tails:	258.4	11.68%	41.93%	3.2%	8.16	3.19%	82.85%
4 Min. Scrub Slimes:	806.2	36.45%	78.38%	3.8%	30.98	12.12%	94.97%
5 Min. Scrub Slimes:	478.2	21.62%	100.00%	2.7%	12.84	5.03%	100.00%
Total:	2,211.8	100.0%		11.6%	255.5	100.0%	

Table 16. Typical Batch Flotation Response for Composite 3A.

FL024.1 Mass Balance	Wt. gms	Wt % at Size	Cum. % Weight	Assay % B ₂ O ₃	B ₂ O ₃ gms	% B ₂ O ₃ of Feed	Cum. B ₂ O ₃ Recovered
2nd Cleaner Conc.	429.4	24.83%	24.83%	36.8%	158.11	88.81%	88.81%
2nd Cleaner Tails	50.6	2.93%	27.75%	4.1%	2.06	1.16%	89.97%
1st Cleaner Tails	140.1	8.10%	35.85%	1.1%	1.52	0.86%	90.83%
Rougher Tails:	282.2	16.32%	52.17%	1.0%	2.93	1.65%	92.48%
Trommel Scrub Slimes:	275.6	15.94%	68.11%	1.4%	3.84	2.16%	94.63%
Fine Scrub Slimes:	149.3	8.63%	76.74%	1.4%	2.15	1.21%	95.84%
Coarse Scrub Slimes:	402.2	23.26%	100.0%	1.8%	7.40	4.16%	100.00%
Total:	1,729.4	100.0%		10.3%	178.0	100.0%	

As can be seen in Tables 15 and 16 the overall recovery of B₂O₃ to the concentrate is 77.17% for Composite 2A rejects and 88.81% for Composite 3A.

The recovery of B_2O_3 to the concentrate, from the feed to flotation after de-sliming, is 98.6% for Concentrate 2A and 98.7% for Composite 3A. The lower overall recovery shown for Composite 2A is likely due to greater loss of B_2O_3 in the Trommel Scrub stage due to the finer particle size of the Composite 2A rejects used in these tests.

The batch flotation tests were operated so as to recover concentrate until the froth was exhausted. During flotation the concentrates were collected for differing time intervals. Typically the initial concentrates were the highest grade and diminished as additional concentrate was collected. The cumulative grade-recovery curve for the second cleaner concentrates for Composites 2A and 3A are presented in Figure 13, which illustrates that there is little difference between Composite 2A and 3A and increased recovery is obtained with a slight decrease in grade..

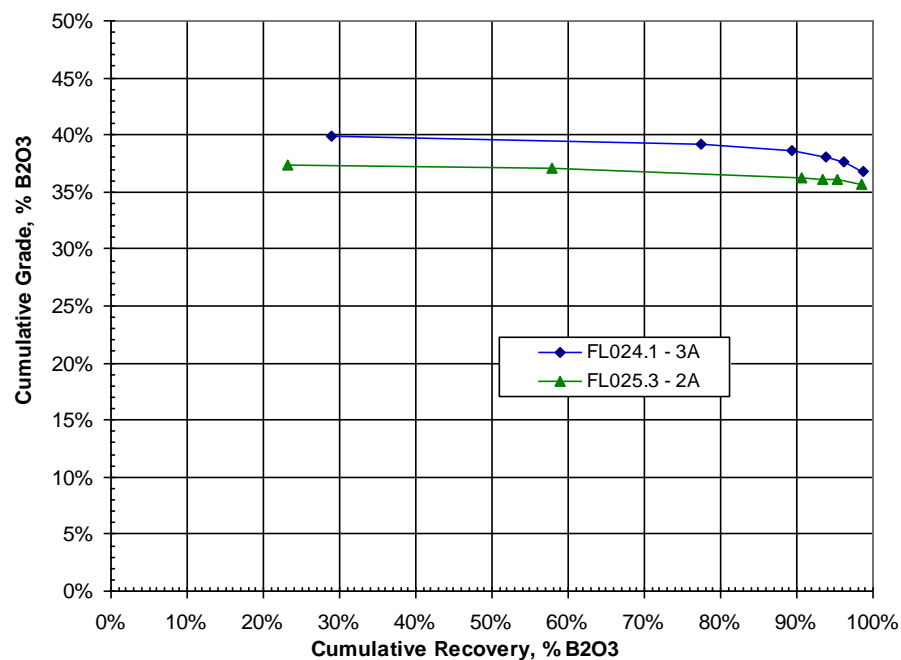

Figure 13. Typical Grade/Recovery Curves for Composites A2 and A3.

13.4 Analytical:

Assays are performed using a wet chemistry titration technique using barium carbonate to precipitate interfering ions. This method was later refined by Minera Sonora Borax to improve accuracy and precision of results. One of the variations on the assay method was to titrate to an equivalence point using a pH meter rather than an indicator endpoint. Variability of the assays was investigated by assaying multiple samples from an individual concentrate and reagent grade boric acid. This comparison is presented in Table 17.

Table 17. Analyses of Boric Acid and Concentrate Using MSB Procedure.

	Boric Acid	FL024.1 2CL. CONC. 1	FL025.3 2CL. CONC. 1
Range, B ₂ O ₃ %:	56.02% - 56.30%	--	--
No. Assays:	8	7	4
Average:	56.09%	39.93%	37.33%
Max:	56.33%	40.66%	37.82%
Min:	55.88%	39.49%	36.87%
StdDev:	0.19%	0.46%	0.40%
COV:	0.34%	1.16%	1.07%

Table 17 shows that the assay of reagent grade boric acid is closely representative of the range of expected for this chemical. Analysis of flotation concentrates using the MSB method shows a standard deviation of 0.40 - 0.46% B₂O₃. It is apparent the MSB method is just as acceptable as other reported titrimetric methods.

13.5 Arsenic:

The average arsenic concentration of the composites is 449 ppm for Composite 2A and 374 ppm for Composite 3A (refer back to Tables 11 and 12). Concentrates (high colemanite) and tails (high clay) for Composite 2A have been assayed by SGS and LTM using ICP methods for arsenic content and this data is presented in Table 18.

Table 18. Arsenic Assays in ppm of Composite 2A Tails and Concentrates.

	Conc. SGS	Conc. LTM	Tails, SGS
No. Assays:	29	10	14
Average:	1079	1104	132
Max:	1480	1176	547
Min:	572	1034	57
StdDev:	191	53	123
COV:	17.7%	4.82%	93.2%

It is readily apparent in Table 18 that the arsenic concentrates with the colemanite. Arsenic assays on concentrate, separated into individual size fractions in the range of 150 micron to 45 micron, show that the arsenic concentration is independent of particle size in this range. Additional tests are planned to determine the deportment of arsenic in the concentrates with ultra-fine grinding prior to cleaner flotation.

13.6 Thermal Processing - Calcining:

Calcining of crude colemanite ores has been used extensively to upgrade the mineral from competent gangue minerals. Traditionally coarse screened ore was heated to around 450 °C where upon the water of crystallization, which makes up 21.9% of the weight of colemanite,

converted to steam and violently disrupted the crystal structure from within. The resultant fine colemanite particles were screened from the coarse gangue that remained unaffected. This technique was typically used on medium grade colemanite where the losses of B_2O_3 to the fines in preparation for calcining were acceptable.

Calcining has been investigated for use in upgrading the de-slimes feed to flotation. Preliminary tests indicate that the de-slimes (-6.3 mm) feed is insufficiently large to support particle size degradation due to formation of internal steam. The grade of the de-slimes material increased by an average of 13% (i.e. 15.1% B_2O_3 to 17.1% B_2O_3) due to the loss of water of crystallization.

Preliminary calcining tests on flotation concentrates are included in Figure 14. The result of calcining concentrates follows the same trend as calcining flotation feed. An average concentrate of 38.6% B_2O_3 increased to 42.2% B_2O_3 with the loss of water of crystallization, an average gain of 3.5% B_2O_3 . Additional calcining experiments are planned.

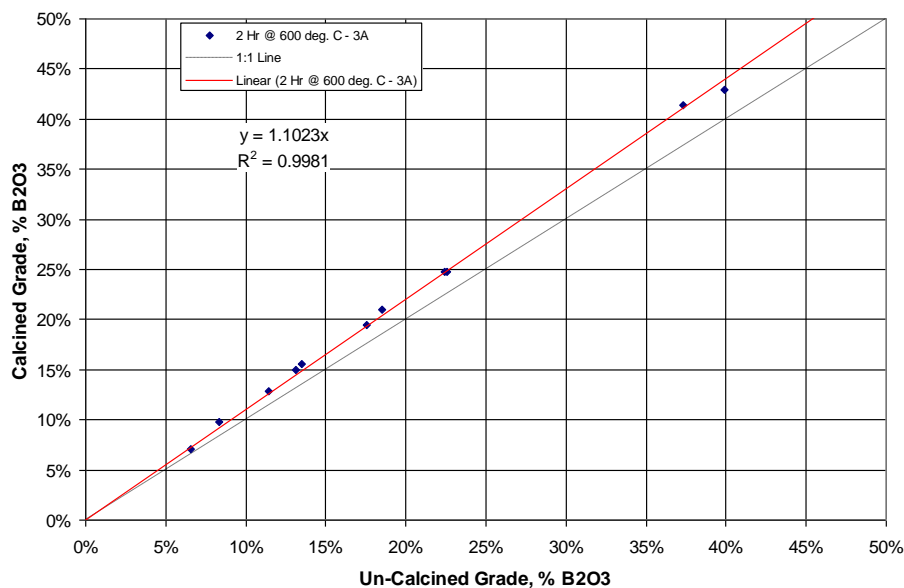

Figure 14. Effect of Calcining on Composite A3.

Test work has demonstrated that calcining is not necessary in order to achieve acceptable colemanite concentrate grades.

13.7 Other Considerations:

Other components of the deposit may add value to the project. These are gypsum and clay.

Gypsum is present in the feed as selenite ($\text{CaSO}_4 \cdot 2\text{H}_2\text{O}$). Selenite appears as relatively large, clean crystal masses. These crystal masses could be easily separated from the de-slimes feed prior to crushing and grinding using optical sorting methods. The sorted gypsum could then be marketed for cement plant admixture. Although the quantity of gypsum reporting to the flotation concentrates appears to be small, removing the gypsum prior to crushing will reduce the tonnage processed by flotation which may reduce operating costs. The reduction in gypsum reporting to flotation may improve the grade of the concentrates.

The de-sliming operation produces relatively clean montmorillonite/illite clay. This clay may have utility in porcelain or tile manufacturing.

No testing has been conducted to date to determine the viability of marketing these byproducts.

Samples tested represent material from the A zone of the Cajon deposit. Little difference was noted between the composites. These composites do not represent zones B or C which have not been tested to date using the proposed flow sheet.

14.0 Mineral Resource Estimates

A preliminary resource estimate was undertaken by the authors of this report in 2011 (Verley et al, 2011) and resulted in inferred borate resources being estimated for the El Cajon deposit based on the results from 9 holes drilled by USBorax and 14 holes drilled by Bacanora in 2010. The current report provides an update and revision of that resource estimate, with resources now being in the indicated category as per CIM resource-reserve classification system. Included in the revised estimate are an additional 30 holes drilled by Bacanora in 2011. Readers are cautioned that the resource estimate does not mean or imply that an economic borate deposit exists at the El Cajon deposit. Further testing will need to be undertaken to confirm economic feasibility of the El Cajon deposit. Mineral resources are not mineral reserves as they do not have demonstrated economic viability.

For the current resource estimate, two different estimation passes were used. Inverse Distance Cubed (ID3) was the primary estimation method from which the final resource calculation was generated. An Ordinary Krig estimation was also performed using the variogram parameters from omnidirectional variograms. In this report, data for the later estimation is considered for mining plans and pit design.

The Cajon target is composed of three mineralized beds, hosted in mid-Tertiary clastic sediments. The lower unit (Unit C) is overlain by a basalt flow, which has been used as marker bed and is locally known as El Cajon Basalt. This mineralized zone crops out, but it is fully replaced by carbonate (CRZ) at surface. The other two zones, Units A (top) and B (middle) overlay the Cajon basalt.

Based on that information, resources were estimated using 6, 8, and 10% B₂O₃ cut-offs. The results of the resource estimation are summarized and categorized in Table 19.

Table 19. Indicated Resource Estimate Summary

Unit	Cut off B ₂ O ₃ %	Tonnage (millions)	Grade B ₂ O ₃ %	Tonnes B ₂ O ₃
A	6	23.89	8.0	1,910,000
	8	7.49	10.8	808,000
	10	3.45	13.2	455,000
B	6	5.36	7.0	375,000
	8	0.81	9.0	72,000
	10	0.10	10.8	11,000
C	6	7.02	8.2	581,000
	8	2.76	10.5	290,000
	10	1.41	12.1	171,000
Total: A,B & C	8	11.06	10.6	1,170,000

The resources estimated for all units are classified as Indicated, according to CIM resource-reserve classification system, and based on the spacing of the available data and the level of confidence on the geological continuity of the mineralization, the confidence on the sampling techniques and assaying procedures. QA/QC analysis of the assays results and mineral density estimations were performed in order to increase the confidence and help to support the above mentioned categorization.

14.1 Methodology

The methodology consisted in the establishment of the necessary parameters to produce solid volumes in order to produce a block model with an assigned grade and tonnage. The analysis was as follows:

14.1.1 Lithology boundaries

Three lithological units were modeled for mineralization at the El Cajon project, known simply as Units A, B, and C in reverse-stratigraphic order (top to bottom, Figure 15). These units represent the borate-bearing colemanite horizons of interest. The attitude of the horizons is approximately 100° azimuth for strike with a dip of 20° to the south. The average thickness of each horizon ranges from 20 to 25m at the drill intercepts.

The lithologic units were modeled in Leapfrog software, based upon surface grids provided by Bacanora Minerals. The units were remodeled to ensure sufficient coverage of the model area as well as to maintain integrity with the drill-holes. Leapfrog is a software modeling package which utilizes the drilling data to make surfaces which exactly honor the drilling data while interpolating areas between holes.

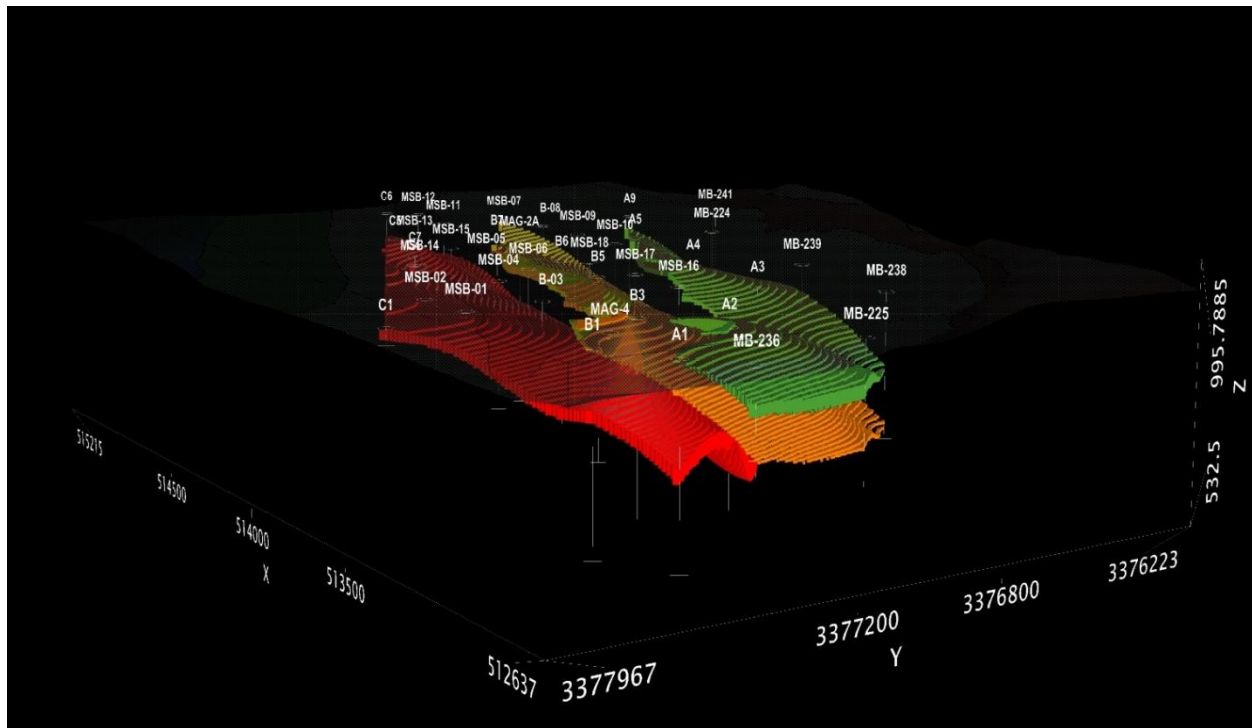

Figure 15. EL Cajon deposit Isometric Model

14.1.2 Topography

The topography was provided in Geosoft Grid (.grd) format, derived from digitized contour maps at 1:50,000 scale. This topography is acceptable for firstpass exploration, but will need to be refined through either local photogrammetric methods or by aerial LiDAR surveys.

14.1.3 Block Model Construction

A. Drillhole Database

The drill-hole database consists of 57 drill-holes, all of which intercept one or more of the mineralized colemanite seams. The total area drilled is approximately 3 square kilometers. The average drill-hole spacing is roughly 200m, though in certain locations (such as between holes MB-241 and MSB-36) the spacing gets as low as 50m. A total of 8,280m of drilling is available, comprising 2,321 total samples analyzed by ICP methods for borate. Sample lengths ranged from 0.61m to 6.1m and averaged 1.5m. Of the 2,321 total samples, 1,183 are situated inside the colemanite horizons and were used for the resource estimation.

B. Composite Database

The drilling data was composited on 3m run lengths differentiated by colemanite unit. Composite size of 3m was selected based on the anticipated block model size (3m vertical blocks being the mineable interval) as well as a reasonable length based on the sample length distribution. This resulted in 644 total composites inside the colemanite horizons.

The samples were also composited at 3m in an effort to bring down the variance for the variography study – the range of variance in the raw drilling is too high for meaningful variograms. Unfortunately, the variance was still too high with the 3m composites to be able to obtain reasonable experimental variograms. Typically the variance should be less than 2 for variography to work well.

An additional study was performed wherein each hole was composited with a single sample per colemanite unit. The variances became 4.12, 1.71, and 1.29 respectively for Units A, B, and C, but the number of samples expectedly reduced dramatically (23, 38, and 14 samples) which would also cause difficulty in obtaining reasonable variogram results.

C. Variography

In spite of the aforementioned concerns with the high variance in the dataset, Omnidirectional Variography was performed both to attempt to identify a reasonable search radius for the block model estimation as well as to interpret whether a more representative drill spacing should be used to increase confidence in the resource and to bring down the variance for future variography studies. An Omnidirectional Variogram was made for each colemanite unit using 25m lag sizes with no lag tolerance.

D. Block Construction

The block model was built as a regular unrotated model using 9x9x3m uniform blocks. Blocks were not allowed to be built above topography to avoid potential for “air blocks” to be estimated. A uniform density of 2.4 was applied globally.

E. Block Estimation

Two different estimation passes were used. Inverse Distance Cubed (ID3) was the primary estimation method from which the final resource calculation was generated. An Ordinary Krig estimation was also calculated using the variogram parameters from the omnidirectional variograms. The Ordinary Krig estimation was done to compare the results with the ID3 estimation as well as to get krig variance values in each block to identify where low and high variance areas exist.

Search radii for the estimation could not be determined from the variograms, so the equation used for the minimum search radius for the block estimations was: Average Data spacing = $\left(\frac{\text{area sampled}}{n}\right)^{1/2}$, where “n” is the number of samples. The total XY area of the block model (allowing for sufficient distance from the perimeter drill holes) was 5,320,000m², and the number of samples was 402. Thus, following the equation above the minimum search ellipse should be 115m. Given that value along with the average drill-hole spacing of 200m, a search range of 200m was used for the major and semi-major axes of the search ellipse. A range of 30m was allotted to the minor direction based on the average thickness of the horizons but with a bit of additional tolerance to account for the irregularity of the horizon trends. The search ellipse was oriented at a strike of 100 azimuth and dipping 20 degrees to the south to emulate the trend of the lithologic units.

Only blocks inside the colemanite wireframe solids were estimated. Their location relative to the colemanite boundary was based on the centroid of the block: if the centroid was inside the horizon, then the block was estimated.

15.0 Mineral Reserve Estimates

There are no mineral reserve estimates for the El Cajon borate deposit.

16.0 Mining Methods

The proposed mining method for the Cajon Deposit is open pit since the attitude of the borate layers facilitates this mining method. Due to the nature of the mineralization, the borate crystals are associated with semi-consolidated to consolidated clays, consequently the mining operation contemplates the usage of explosives, although less consolidated, near surface material may be stripped and mined as an earth-moving operation. The mineralized units being part of this study are generally striking northwesterly and dipping 15-20 degrees to the southwest.

The mine site is located in gentle topography with elevations ranging from 885 to 925 m ASL with a major drainage trending to the north and northwest. Processing plant and the tailing ponds have been planned to be installed at the northeastern most portion of the area and the waste material in the westernmost portion of the property (Figure 16).

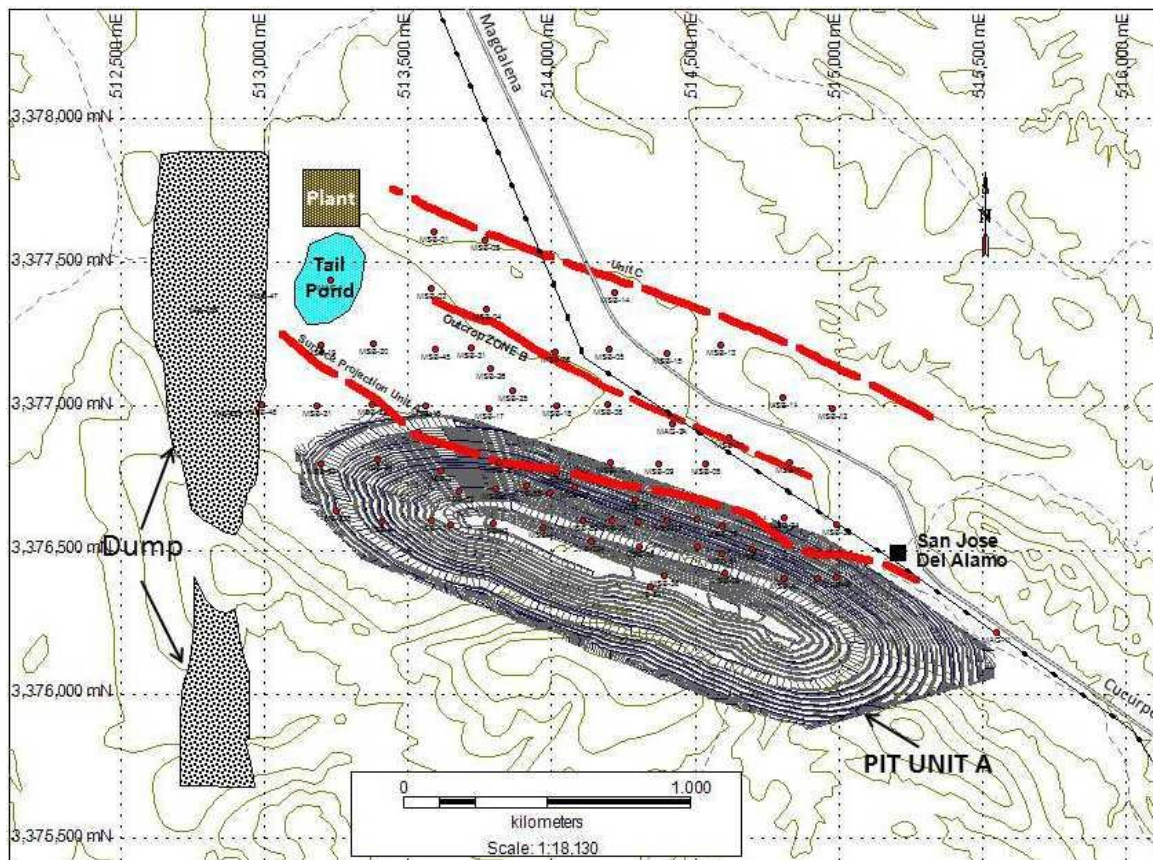

Figure 16. Plan of Proposed Mine Pit, Plant, Dumps and Tailings.

The project is being planned in two stages of production. First, the production of 50,000 tonnes of colemanite concentrates at 40 to 42% B_2O_3 per year with an option of produce boric acid using low-grade ore. A mine life of 25 years is expected, mining all of the mineralized units to a maximum depth of approximately 120 m in 3 metre high benches. The area covered by the entire project is about 2,000 by 1,000 metres (200 ha). Mine dilution factor is 15% with the stripping ratio increasing by 0.5 per year.

The mining operation will begin with the mining of Unit A (Figure 17) with an open pit that will be pushed-back in order to mine unit B and subsequently unit C. For the mine plan, a pit optimization was performed using Mine-Sight software with parameters obtained from the resource estimation. The outcome of this analysis, for differing cut-off grades, was a division of potential insitu-colemanite-bearing material and waste proposed to be mined as listed in Table 20.

Table 20. Potential Mineral-Waste ratio and grade (B_2O_3)

Cut-Off (B_2O_3 %)	Insitu Mineral ¹ (Tonnes)	Waste Total (Tonnes)	Insitu Grades (B_2O_3 %)	Waste to insitu mineral ratio
6%	16,642,149	21,757,727	8.01	1.3
8%	5,414,759	32,985,116	10.45	6.1
10%	2,325,627	36,088,458	12.75	12.0

¹ Mineral = colemanite-bearing beds

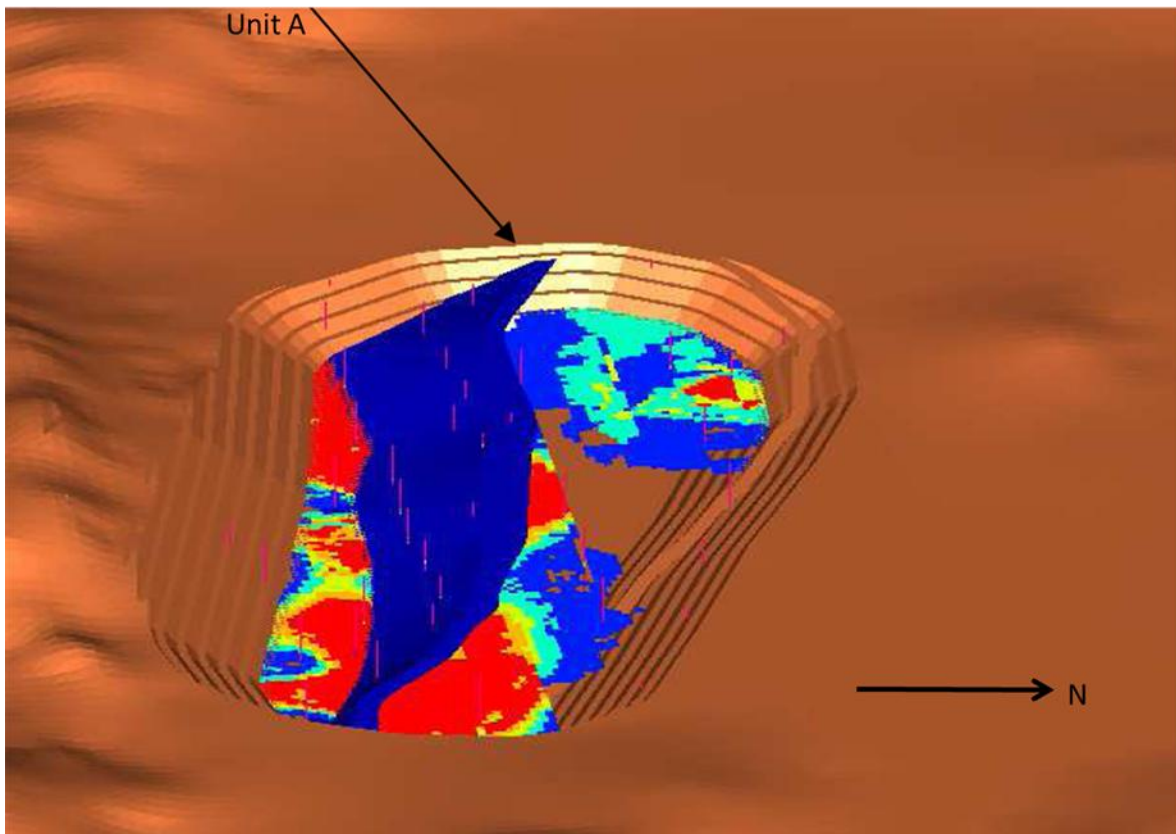

Figure 17. View of Planned Pit relative to Colemanite-bearing Unit A

Equipment anticipated to be used in mining of the colemanite will consist of the items listed in Table 21. Mining equipment is standard operating gear for small mining operations and does not requiring special orders from manufacturers.

Table 21. Anticipated Mining Equipment

Quantity	Item
2	Caterpillar D9 bulldozers
2	Caterpillar 938 H loaders
4	60 tonne haul trucks (77G)
1	Caterpillar 450E Excavator
1	Track-mounted blast hole drill, Cat MD 50-50
1	Caterpillar 140M grader
1	Water tank truck

17.0 Recovery Methods

As discussed in Item 13, laboratory testing has identified a suitable process for the recovery of a colemanite concentrate consisting of a combination of scrubbing, de-sliming and flotation with a recovery range of 77-88% B_2O_3 . In addition, a boric acid line may be installed in the processing plant, in order to produce a further boron product.

17.1 Colemanite

The proposed colemanite recovery flow sheet for the El Cajon Project is based on a combination of conventional metallurgical unit operations. No novel or untried technology is envisioned for the process. These unit operations are duplicated as far as possible in the pilot plant design to allow detailed testing and to obtain engineering data for scale-up. A block diagram of the proposed process is included as Figure 18.

The flow sheet consists of the following major steps:

1. Primary scrubbing.
2. De-sliming.
3. Crushing.
4. Secondary scrubbing/de-sliming
5. Grinding.
6. Rougher flotation.
7. Attrition scrubbing of flotation concentrates.
8. Two stages of cleaner flotation of attritioned concentrates.

Process development is on-going and additional unit operations may be required in a production facility. Any additional unit operations will be included only if they provide significant technical or economic benefit.

Projected energy requirements to produce a tonne of colemanite concentrate are 100 kw-hours of electricity, 50 cubic metres of natural gas and 2.86 tonnes of diesel fuel. Water requirements are one tonne of water for each tonne of colemanite concentrate produced. Flotation reagents are estimated to cost approximately \$12 per tonne of colemanite concentrate produced.

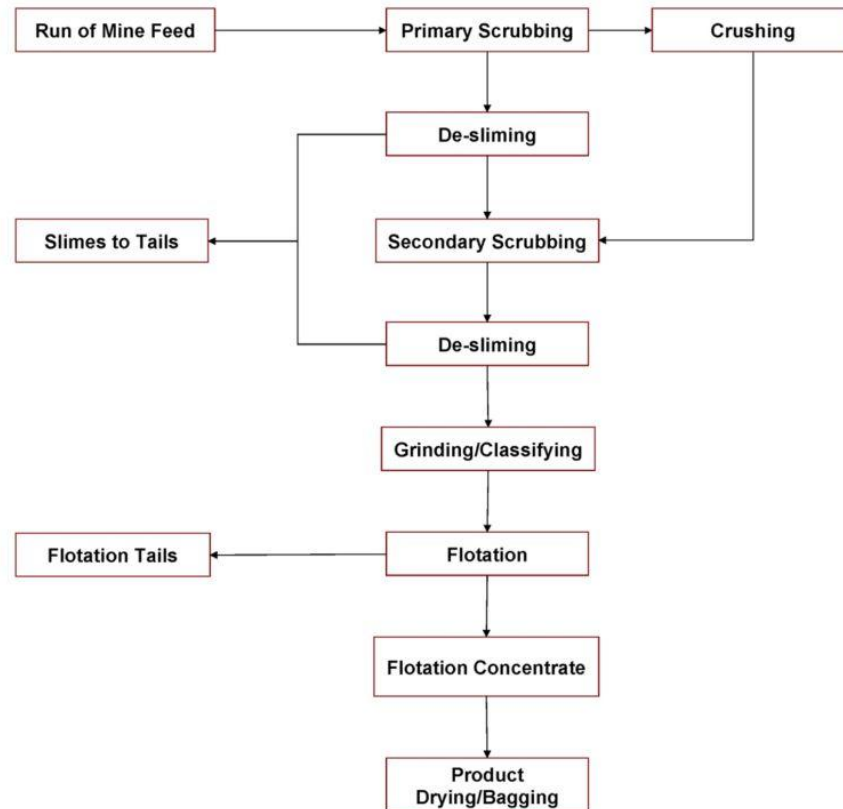

Figure 18. Conceptual Colemanite Process Flow Diagram.

17.2 Boric acid

The production of boric acid is contemplated at a later stage in the project using colemanite-bearing material as a feed stock. The advantage of going to boric acid production is that lower grade colemanite zones can be used, effectively increasing the available resource base and mine life. In addition, the in situ leaching of deep colemanite horizons, as found at the Represo occurrence, utilizing the well-established “Duval process” (Atwood et al.), could be feasible. Furthermore, boric acid commands a higher price than colemanite concentrates. The capital costs of a boric acid production line are more expensive than a colemanite-only plant, consequently it is recommended that studies be undertaken to determine the feasibility of adding a boric acid line to the project in order that production can consist of either boric acid only or a combination of boric acid and colemanite concentrates.

Laboratory experience shows that it might be possible to use low grade material and upgrade it by flotation to produce a colemanite concentrate to be used as ore-feed for boric acid.

A flow sheet for such a process is illustrated in Figure 19. It is recommended that a circuit to produce boric acid to be incorporated in the colemanite pilot plant in order to provide samples to potential customers and to provide data for the economic analysis of boric acid production from El Cajon colemanite.

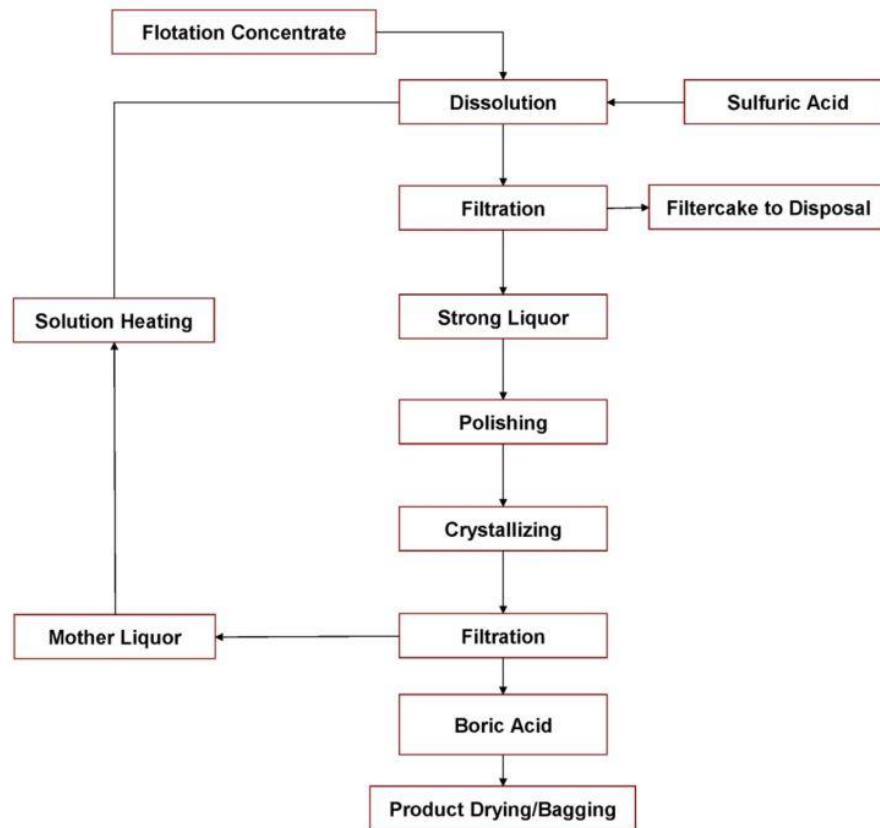

Figure 19. Conceptual Boric Acid Process Flow Diagram.

18.0 Project Infrastructure

The infrastructure in the region consists of the following:

1. A north-south natural gas pipeline crosses along the town of Magdalena de Kino and
2. A high tension power-line crosses within 1 km of the northern portion of the Cajon deposit,
3. Railroad sidings are situated approximately 10 km from the deposit. The rail line goes from Nogales, providing a point of entry to the United States, through Magdalena de Kino and on to the port of Guaymas, located about 300 km southwest of the deposit. Guaymas provides a point of departure for potential shipments to international markets.
4. Paved all season highway (Magdalena de Kino – Cucurpe) through the Property and close to the deposit.

Process water is available from either local wells or from a 75 ha lake formed behind a dam across the El Yeso River. The lake is located 6 km northwest of the proposed mine-site. Ranch owners have been supportive in supplying sufficient water for drilling

programs. Negotiations are underway with the ranch owners and the local municipality to secure sufficient water for mine and process operations.

There is a skilled labour pool in the area that can support new mining projects.

The proposed mine plan envisages waste dumps to be located immediately to the northwest of the open pit. There is adequate level ground in this area to safely store mine waste. The processing plant will be located immediately to the northeast of the open pit beside the Magdalena de Kino – Cucurpe road with the tailing pond established immediately to the north across the road. There is adequate level ground in this area to safely impound process tailings.

Mining, plant construction, labour, material, power, transportation and water procurement contracts are currently under negotiation.

19.0 Market Studies and Contract

Colemanite, as an industrial mineral commodity is used as raw material for a number of end products such as fiber glass, glass and ceramics. Bacanora has contacted colemanite consumers and ascertained that there is a definite interest from North American fiberglass and tile manufactures for new colemanite supply. Inquiries have also been received by Bacanora from a number of potential end users and brokers on a confidential basis. As a result of these inquiries it is concluded that there exists potential market demand in excess of 100,000 tonnes per annum for new supplies of colemanite concentrates.

The Company does not have marketing contracts for the sale of colemanite at present. Prior to entering into any contracts end-users will require product samples to test in their manufacturing lines. Bacanora will satisfy this requirement with colemanite concentrates from the proposed pilot plant that is recommended to be built in Hermosillo.

Colemanite is not an exchange traded commodity; consequently there is no spot price for colemanite concentrates. Concentrate prices are negotiated on a supply-demand basis generally with end-users. Current colemanite prices range from between \$US630 to \$US730 per tonne for concentrates averaging between 40-42% B₂O₃ based on industrial minerals price reports (Industrial Minerals Magazine, September 2011). Boric acid prices range from \$US800 to \$US1,250/tonne depending on purity. Prices FOB Chile are reported at \$US1,250/tonne (Industrial Minerals website: www.indmin.com).

The QPs have reviewed the available information that the Company has concerning potential markets and pricing and is of the opinion that these support the assumptions in this report and warrant further detailed studies to confirm the feasibility of the proposed project.

Bacanora has not entered into any material commercial agreements with suppliers or purchasers of colemanite concentrates or boric acid.

20.0 Environmental Studies, Permitting and Social or Community Impact

Permit applications requesting the change of land over an area of 20 hectares has been filed at the Secretary of Ecology and authorization is in progress.

A survey of flora and fauna over an area of 160 hectares has been conducted by the method of transects in order to assess the density and diversity of species. There are no protected species or species that might be in danger of extinction with the development of the project.

Bacanora proposes to maintain a constant monitoring of the areas in and around El Cajon that might generate and/or develop any environmental risk. A mine closure plan (remediation and reclamation) is being developed for implementation during the last two years of the projected mine life. The estimated cost of mine closure is \$US1 million. Mine closure will essentially consist of slope stabilization, re-contouring and seeding waste piles, stabilizing and monitoring tailings disposal sites, as well as removal of mine and plant buildings and infrastructure.

In order to maintain good community relationships, most of the labour contracted will be local. Health, safety environmental and community training programs will be implemented before, during and after the project development.

21.0 Capital and Operating Costs

Key assumptions used to estimate operating and capital costs are tabulated below.

Table 22. Key Operating Cost Assumptions

ITEM	ASSUMPTION	Unit	Cost US\$	Cost/ton of Col.
Electricity	100 kwh are need to produce 1 ton of col ¹	kwh	0.15	18.20
Natural gas	50 m3 are need to produce 1 ton of col	m3	25.60	11.90
Water	50k tons of water to produce 50K tons of col	tonne	0.44	0.44
Fuel	143 tons of diesel to produce 50K tons of col	tonne	880.00	2.52
Labor	53 employees (several levels)			20.88
Storage/Shipping	Considers FOB to Guaymas Port	tonne		15.00
Reagents/Calcining	Flotation reagents and drying/calcining	tonne		12.00
Total				\$ 80.94

¹ col = colemanite

Mining cost is estimated at US\$ 2.50 per tonne of material (colemanite-bearing material and waste) with an average of material mined per year of 1,675,475 tonnes. Surface rights and other permits add US\$ 5.00 per tonne of product. Processing costs are estimated at US\$ 170 per tonne of product. Table 23 summarizes the operating costs for mining and processing:

Table 23. Estimated Annual Mining and Processing Costs

Operating Costs/year		
Plant	US\$/tonne	US\$/year
Water	0.44	22,000
Electricity	18.20	910,200
Natural gas	11.90	595,200
Storage/Shipping	15.00	750,000
Other reagents	12.00	600,000
Fuel	2.52	125,840
Labour	8.40	420,000
Total	60.06	3,003,240
Mine		
Mineral ¹ @ US\$2.50/tonne		577,750
Waste @ US\$2.50/tonne		3,611,000
Surface right/year		250,000
Labour		420,000
Total	88.78	4,438,750
Administration		
Salary & wages		210,000
Total	\$US169.72	\$US8,485,990

¹ Mineral = colemanite-bearing material

Capital requirements to build the mine and processing plant as well as supply sustaining capital and funding for mine closure are estimated at US\$7.25 M (Table 24). Of this amount US\$ 2M is required to build the mine, US\$ 2.75M to build the processing plant, US\$ 0.5M for feasibility studies, US\$ 1M for sustaining capital and US\$ 1M for closing

Table 24. Development Capital Requirements

Capital cost Magdalena - Cajon	
Mine	US\$
Equipment/Contracted	1,500,000
Infrastructure	400,000
Support	100,000
Processing plant	
Flotation Plant/calcining	2,000,000
Infrastructure	500,000
Support	250,000
Pre-Feasibility study	500,000
Sustaining capital	1,000,000
Closing	1,000,000
Total	\$US7,250,000

22.0 Economic Analysis

Preliminary economic analysis of the project is based on an annual production rate of 50,000 tonnes of colemanite concentrate (40-42% B₂O₃), with a mine life of 25 years and run-of-mine feed to the processing plant averaging 10% to 12% B₂O₃. The project is subjected to an annual royalty of 6% of net profits and a government taxation rate of 34%.

Potential project cash flows, net present values at various discount rates and internal rate of return are listed in Table 23 for the life of the project and based on colemanite concentrate prices of \$US400, \$US500 and \$US600 per tonne FOB Guaymas. The net cash flow ranges from \$US175 M to \$US328 M; net present values ranges from \$US80 M to \$US146 M at an 8% discount rate; internal rate of return for the project ranges from 18.1% to 31.9%. Project pay-back time is estimated at less than four years.

The preliminary economic assessment includes forward looking information including, but not limited to assumptions concerning colemanite prices, cash flow forecasts, project capital and operating costs, commodity recoveries, mine life and production rates. Readers are cautioned that actual results may vary from those presented. Further testing will need to be undertaken to confirm economic feasibility of the El Cajon deposit. Mineral resources used in this preliminary economic analysis are not mineral reserves as they do not have demonstrated economic viability.

Table 25. Cash Flow and Net Present Value Analysis Projected Over Life of Mine

Colemanite Concentrate Price Scenario		\$US400/tonne	\$US500/tonne	\$US600/tonne
Cashflow Summary		US\$ million	US\$ million	US\$ million
Revenue		480	600	720
Operating Costs		198	198	198
Royalty		15.4	22.2	28.9
Capital Costs		7.25	7.25	7.25
Taxation		82	119	156
Net Cashflow		175	252	328
Net Present Value	Discount rate	NPV US\$ Million	NPV US\$ Million	NPV US\$ Million
	10%	68	96	124
	9%	74	104	135
	8%	80	113	146
	7%	87	123	159
Internal Rate of Return		18.1%	24.8%	31.5%
Cost Cover Ratio		2.42	3.02	3.62
		41.4%	33.1%	27.6%

23.0 Adjacent Properties

The Magdalena Basin is host to several industrial minerals deposits, including the Unimin borate deposit and the Yeso Gypsum Mine (Figure 20).

23.1 Unimin Borate Deposit:

The Unimin or Tinaja Del Oso (“TDO”) deposit is located in a concession that was originally part of the US Borax – Vitro joint venture lands. The deposit was discovered in 1977 and has unpublished, internal US Borax resource estimates.

The TDO deposit consists primarily of colemanite and howlite mineralization. It outcrops for approximately 3,000 m and is 30 m to 47 m thick (Vidal, 2007b). The lowest zone contains 2.3 metres of howlite and colemanite hosted in black shales. The unit is unconformably overlain by a barren sedimentary breccia which in turn is overlain by a turbiditic breccia containing gypsum crystals. Above this unit a clay unit with marl containing colemanite rosettes represents the central portion of the deposit. The thickest zone of the deposit is approximately 12 m and is comprised of sedimentary mudstone breccia. The colemanite is found in the breccia as veinlets and disseminations (Vidal, op. cit.).

Exploration by the joint venture on the TDO deposit included 2 shafts and a total of 128 drill holes. All holes were vertically drilled on a 50 m x 50 m grid pattern. There was sufficient drilling to determine a US Borax internal reserve estimate (non-43-101 compliant) on the central and eastern portion of the deposit. Insufficient drilling in the western portion of the deposit inhibited the development of an ore reserve across the entire deposit. The internal calculations used a cutoff grade of 10% B₂O₃ and estimated >3 Million tons of pure colemanite (or 3.03 million tons of boric acid equivalent). The assumptions surrounding this estimate are unknown.

Internal metallurgy tests, processing plans, recovery tests and economic models were also conducted on this deposit. When US Borax and Vitro dissolved the joint venture, Vitro purchased the TDO deposit concession and subsequently entered into a joint venture agreement with Unimin. They currently hold the title to the concession.

23.2 Yeso Mine:

There is no published information on the Yeso mine. The following information was provided as personal communication from Vidal 2009 based on field visits between 1995 and 2008.

The Yeso Gypsum Mine is located in the eastern portion of the Magdalena basin. The deposit is a northwest-southeast trending syncline with the mine pit located in the middle of the syncline. Both margins (northeast and southwest) are composed of two small anticlines.

The deposit is a gypsiferous lenticular body composed of four major units. The lowest unit is composed of 80-85% of gypsum (approx.) with black, carbonaceous shales with arsenic (realgar and orpiment) in the matrix. This unit contains less than 1% of disseminated borates. The second unit, a one metre thick black carbonaceous shale, conformably overlies the gypsum unit and is barren. The third unit is composed of 85-90% gypsum and 1-2% borates (no visible colemanite, the borate is howlite altered to calcite) in a light gray to black carbonaceous shaly matrix. It conformably overlies the lower two units. The uppermost level is composed of

lightgray shale with 50-60% gypsum and 2-3% of disseminated and nodular borates being altered to calcite. The nodules are 1-5 cm in diameter.

The current mine production is 10,000 tons per month, which are being purchased by two cement plants located nearby Hermosillo (5,000 tons each).

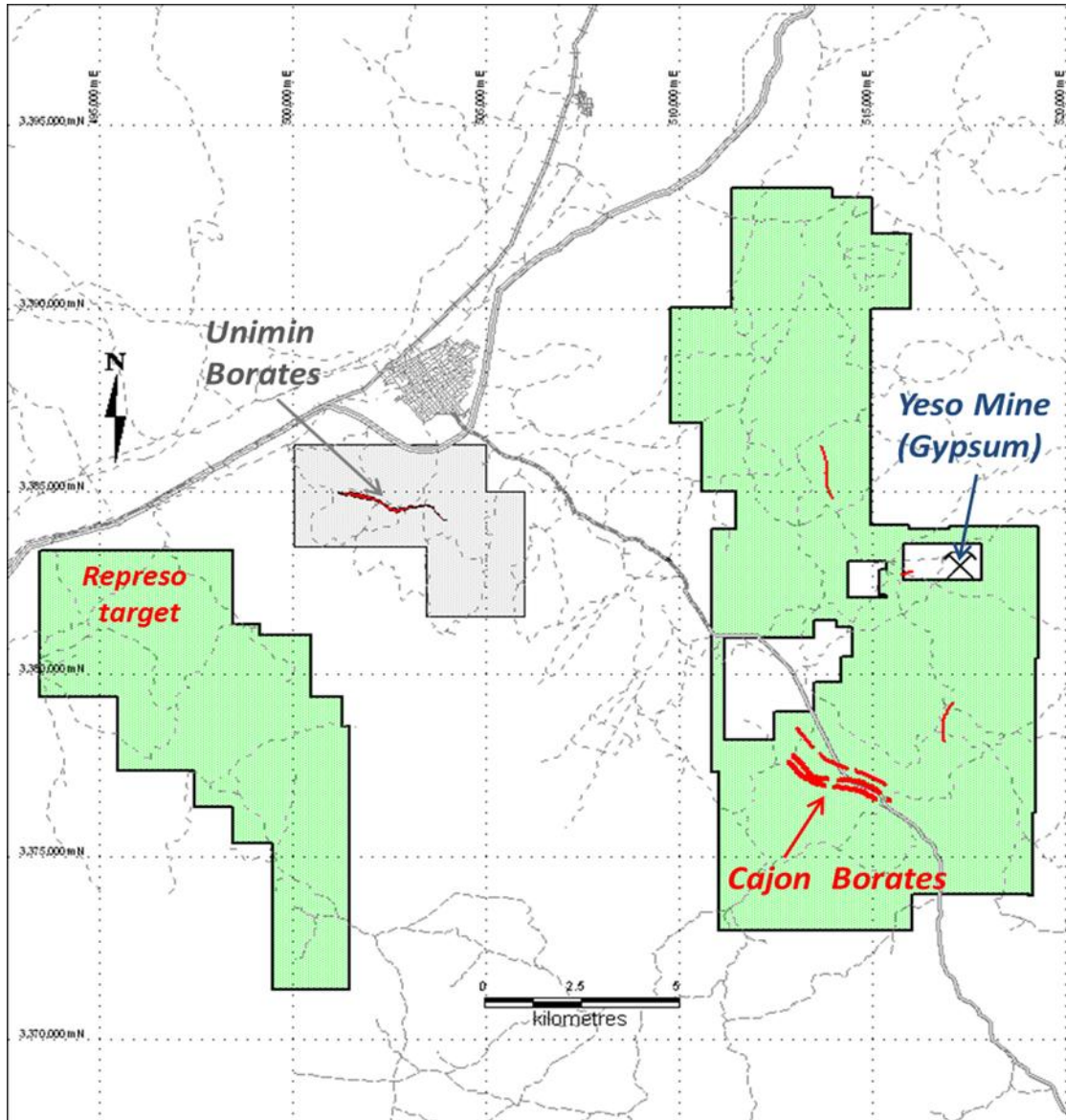

Figure 20. Map of Adjacent properties

24.0 Other Relevant Data and Information

There is no other relevant data or information concerning the El Cajon deposit.

25.0 Interpretations and Conclusions

Exploration by Bacanora Minerals Ltd on the El Cajon borate deposit has produced an indicated borate resource estimate for the deposit.

A total of 48 diamond drill holes tested El Cajon in 2010 and 2011. The results of these holes confirmed the interpretation that borate mineralization consisting of colemanite and howlite occurs in 3 separate horizons (Units A, B and C). The configuration of the deposit is that of a gently dipping southwesterly plunging synclinal structure, with minor anticlinal warps.

The data density while wide spaced is adequate for this stage of exploration and resource estimation. Based on the writers' examination of the data it is their opinion that it is reliable and meets or exceeds industry standards for such data.

The estimated resources for units A, B and C can be classified as Indicated Mineral Resources, based on the spacing of the available data and the level of confidence on the geological continuity of the mineralization, the confidence on the sampling techniques and assaying procedures. Quality assurance and control analysis of the assays results and mineral density estimations were performed in order to increase the confidence and help to support the resource categories. There were no quality assurance or control problems found by this analysis.

A preliminary resource of 11 million tonnes in the indicated category with an average grade of 10.6 % B₂O₃, using a cut-off of 8% B₂O₃ and 3 metres as minimum thickness is estimated for El Cajon.

Based on the results of work conducted on the Cajon deposit in the Magdalena project area, further work is warranted on the deposit in order to upgrade and expand the resource and to advance the project to pre-feasibility.

In the QPs' opinion, the work conducted by Bacanora Minerals Ltd on the El Cajon deposit met the original objective of estimating a borate resource and providing data and information for a preliminary economic assessment.

26.0 Recommendations

Due to the nature of the borate market, and in order to provide assurance that a marketable borate concentrate can be produced from the El Cajon deposit it is recommended that:

1. bulk sampling of the deposit be undertaken,
2. a pilot plant designed to produce marketable concentrates be constructed; and that such pilot plant be of a design that will be similar or scalable to a larger industrial plant,
3. borate concentrates and boric acid produced from the pilot plant be distributed to potential buyers in order to ascertain the value of the product.

The object and outcome of these recommendations are to provide a pre-feasibility study that will support continued development of the El Cajon borate deposit.

The estimated cost of the recommended program (Table 26) is in the order of \$US1,250,000.

Table 26. Estimated Cost of Recommended Program

Item	Estimated Cost
Pilot Plant Equipment	\$400,000
Pilot Plant construction	\$200,000
Pilot Plant operation	\$300,000
Bulk sampling	\$200,000
Administration, supervision & reporting	\$150,000
Total	\$US1,250,000

27.0 References

- Atwood, G.E., D.E. Cochran, C. Burnett, P.O Tyree and A.W. Fletcher, 1984: Cyclic Solution Mining of Borate Ores, U.S Patent 4,475,771 issued to Duval Corporation.
- Barker, J.M., and Lefond, S.J., 1984. Borates: Economic Geology and Production, Proceedings of a symposium, Society of Mining Engineers.
- Fox, D., MSc, PGeo, 2009: Magdalena-Tubutama Exploration Concessions, Northern Sonora State, Mexico, SEDAR filed Independent Technical Report (NI 43-101) for Bacanora Minerals Ltd.
- Miranda-Gasca, M.A., Gomez-Caballero, J.A and Eastoe, C.J., (1998), Borate deposits of Northern Sonora, Mexico-Stratigraphy, Tectonics, Stable Isotopes, and Fluid Inclusions, Economic Geology Vol. 93,510 – 523 p.
- Verley, C.G., R. Calles Montijo and M.F. Vidal, 2011: Preliminary Resource Estimate for the El Cajon Borate Deposit, Magdalena Basin Project, Sonora, Mexico, SEDAR filed Independent Technical Report (NI 43-101) for Bacanora Minerals Ltd.
- Vidal, M., 1988: Geology and Mineralization of the KinoShaft, Tinaja del Oso Colemanite Orebody. Magdalena, Sonora, Mexico, InternalReportfor Materias Primas Magdalena.
- Vidal, M., and Quiroz F., 1989. Estratigrafía de las Unidades II y V de la Porción Oriental del Yacimiento de Colemanita Tinaja del Oso, Magdalena, Sonora, Mexico, InternalReportfor Materias Primas Magdalena.
- Vidal, M., 1995. The Magdalena basin gypsum deposit. Field report and assay results,Internal Report for MineraSanta Margarita SA de CV.
- Vidal, M., 2003a: General Geology of the Magdalena Basin and Geology of “La Bellota and Cajon” Area, SE Portion of the Magdalena Basin, Sonora, Mexico, Internal Report for MineraSanta Margarita SA de CV.
- Vidal, M., 2003b: First Round Drilling Campaign in the Bellota-Cajon Area, SE Portion of the Magdalena Basin, Sonora, Mexico, Internal Report EX-03-17 for MineraSanta Margarita SA de CV.
- Vidal, M., 2004: Results of the Early 2004, Drilling Campaign, Magdalena Basin, Sonora, Mexico, Internal Report for MineraSanta Margarita SA de CV.
- Vidal, M., 2005: Results of the Late 2004, Drilling Campaign, Magdalena Basin, Sonora, Mexico, Internal Report for MineraSanta Margarita SA de CV.
- Vidal, M., 2007a: Geology of the Magdalena Basin, Sonora, Mexico, InternalReportfor Minera Santa Margarita SA de CV.
- Vidal, M., 2007b: La Tinaja Del Oso Colemanite Deposit (TDOCD), Magdalena Basin, Sonora, Mexico, InternalReportfor Minera Santa Margarita SA de CV.